



KS156P-TGU & KS215P-TGU

15.6" & 21.5" Industrial Touch Panel PC
User's Manual

Copyright

This publication contains information that is protected by copyright. No part of it may be reproduced in any form or by any means or used to make any transformation/adaptation without the prior written permission from the copyright holders.

This publication is provided for informational purposes only. The manufacturer makes no representations or warranties with respect to the contents or use of this manual and specifically disclaims any express or implied warranties of merchantability or fitness for any particular purpose. The user will assume the entire risk of the use or the results of the use of this document. Further, the manufacturer reserves the right to revise this publication and make changes to its contents at any time, without obligation to notify any person or entity of such revisions or changes.

Changes after the publication's first release will be based on the product's revision. The website will always provide the most updated information.

© 2024. All Rights Reserved.

Trademarks

Product names or trademarks appearing in this manual are for identification purpose only and are the properties of the respective owners.

FCC and DOC Statement on Class A

This equipment has been tested and found to comply with the limits for a Class A digital device, pursuant to Part 15 of the FCC rules. These limits are designed to provide reasonable protection against harmful interference when the equipment is operated in a residential installation. This equipment generates, uses and can radiate radio frequency energy and, if not installed and used in accordance with the instruction manual, may cause harmful interference to radio communications. However, there is no guarantee that interference will not occur in a particular installation. If this equipment does cause harmful interference to radio or television reception, which can be determined by turning the equipment off and on, the user is encouraged to try to correct the interference by one or more of the following measures:

- Reorient or relocate the receiving antenna.
- Increase the separation between the equipment and the receiver.
- Connect the equipment into an outlet on a circuit different from that to which the receiver is connected.
- Consult the dealer or an experienced radio TV technician for help.

Notice:

1. The changes or modifications not expressly approved by the party responsible for compliance could void the user's authority to operate the equipment.
2. Shielded interface cables must be used in order to comply with the emission limits.

Table of Contents

Chapter 1 - Introduction	6
I/O Overview	6
KS156P-TGU.....	6
KS215P-TGU.....	6
Dimensions	6
KS156P-TGU.....	6
KS215P-TGU.....	6
Key Features	7
Specifications	8
Chapter 2 - Hardware Installations	10
Removing the Chassis Cover	10
Installing a SSD Tray	11
Installing an M.2 Card	12
Installing an Antenna	13
Mounting Options.....	14
VESA Mount- KS156P-TGU.....	14
VESA Mount- KS215P-TGU.....	14
Panel Mount.....	15
Panel Mount - KS156P-TGU.....	15
Panel Mount - KS215P-TGU.....	15
Chapter 3 - System Settings	16
System Layout.....	16
Jumper Settings.....	17
Clear CMOS (JP1).....	17
COM 4 RS232 Power (JP3).....	17
COM 3 RS232 Power (JP2).....	18
SATA Selection (JP8).....	18
eDP Inverter Power (DPJP1).....	19
Panel Inverter Power (DPJP2).....	19
Panel Power Jumper (DPJP3).....	20
Panel Backlight Selection (DPJP4).....	20
PIN Assignment.....	21
CASEOPEN.....	21
SMBus.....	21
Digital I/O Power	22
Digital I/O	22
COM 1 & COM 2	23
COM 3 & COM 4	23
USB 5/6	24
USB 7/8	24
SATA0/1 HDD Power.....	25
Front Audio.....	25
LCD/Inverter Power	26
LVDS	27
eDP	28
Chapter 4 - BIOS Settings	29
Overview	29
Main.....	30
Advanced	30
CPU Configuration.....	31
Power & Performance.....	31
Power & Performance ▶ CPU- Power Management Control	32
PCH-FW Configuration	32

Trusted Computing.....	33
PTN3460 Configuration	33
NCT6126D Super IO Configuration	34
NCT6126D Super IO Configuration ▶ Serial Port 1, 2 Configuration	34
NCT6126D Super IO Configuration ▶ Serial Port 3, 4 Configuration	35
NCT6126D HW Monitor	35
NCT6126D HW Monitor ▶ Smart FAN Function	36
Serial Port Console Redirection	36
Serial Port Console Redirection ▶ Console Redirection Settings	37
ACPI Settings.....	38
USB Configuration	39
Network Stack Configuration.....	39
NVMe Configuration.....	40
USB Power Control.....	40
Chipset	41
System Agent (SA) Configuration	41
Chipset	42
System Agent (SA) Configuration	42
PCH-IO Configuration	43
PCH-IO Configuration ▶ PCI Express Configuration	43
PCH-IO Configuration ▶ SATA Configuration	44
PCH-IO Configuration ▶ HD Audio Configuration	44
Security	45
Secure Boot.....	45
Boot	46
Save & Exit	46
Updating the BIOS.....	47
Notice: BIOS SPI ROM.....	47

About this Manual

This manual can be retrieved from the website.

The manual is subject to change and update without notice, and may be based on editions that do not resemble your actual products. Please visit our website or contact our sales representatives for the latest editions.

Warranty

1. Warranty does not cover damages or failures that arises from misuse of the product, inability to use the product, unauthorized replacement or alteration of components and product specifications.
2. The warranty is void if the product has been subjected to physical abuse, improper installation, modification, accidents or unauthorized repair of the product.
3. Unless otherwise instructed in this user's manual, the user may not, under any circumstances, attempt to perform service, adjustments or repairs on the product, whether in or out of warranty. It must be returned to the purchase point, factory or authorized service agency for all such work.
4. We will not be liable for any indirect, special, incidental or consequential damages to the product that has been modified or altered.

About this Package

The package contains the following items. If any of these items are missing or damaged, please contact your dealer or sales representative for assistance.

- 1 Touch Panel PC
- 1 Quick Installation Guide
- 1 Poron Foam

Note: The items are subject to change in the developing stage. The product and accessories in the package may not come similar to the information listed above. This may differ in accordance with the sales region or models in which it was sold. For more information about the standard package in your region, please contact your dealer or sales representative.

Static Electricity Precautions

It is quite easy to inadvertently damage your PC, system board, components or devices even before installing them in your system unit. Static electrical discharge can damage computer components without causing any signs of physical damage. You must take extra care in handling them to ensure against electrostatic build-up.

1. To prevent electrostatic build-up, leave the system board in its anti-static bag until you are ready to install it.
2. Wear an antistatic wrist strap.
3. Do all preparation work on a static-free surface.
4. Hold the device only by its edges. Be careful not to touch any of the components, contacts or connections.
5. Avoid touching the pins or contacts on all modules and connectors. Hold modules or connectors by their ends.



Important:

Electrostatic discharge (ESD) can damage your processor, disk drive and other components. Perform the upgrade instruction procedures described at an ESD workstation only. If such a station is not available, you can provide some ESD protection by wearing an antistatic wrist strap and attaching it to a metal part of the system chassis. If a wrist strap is unavailable, establish and maintain contact with the system chassis throughout any procedures requiring ESD protection.

Safety Precautions

- Use the correct DC / AC input voltage range.
- Unplug the power cord before removing the system chassis cover for installation or servicing. After installation or servicing, cover the system chassis before plugging in the power cord.
- There is danger of explosion if battery incorrectly replaced.
- Replace only with the same or equivalent specifications of batteries recommend by the manufacturer.
- Dispose of used batteries according to local ordinance.
- Keep this system away from humid environments.
- Make sure the system is placed or mounted correctly and stably to prevent the chance of dropping or falling may cause damage.
- The openings on the system shall not be blocked and shall be kept in distance from

other objects to make sure of proper air ventilation to protect the system from over-heating.

- Dress the cables, especially the power cord, so they will not be stepped on, in contact with high temperature surfaces, or cause any tripping hazards.
- Do not place anything on top of the power cord. Use a power cord that has been approved for use with the system and is compliant with the voltage and current ranges required by the system's electrical specifications.
- If the system is to be unused or stored for a long time, disconnect it from the power source to avoid damage by transient overvoltage.
- If one of the following occurs, consult a service personnel:
 - The power cord or plug is damaged.
 - Liquid has penetrated the system.
 - The system has been exposed to moisture.
 - The system is not working properly.
 - The system is physically damaged.
- The unit uses a three-wire ground cable which is equipped with a third pin to ground the unit and prevent electric shock. Do not defeat the purpose of this pin. If your outlet does not support this kind of plug, contact your electrician to replace the outlet.
- Disconnect the system from the electricity outlet before cleaning. Use a damp cloth for cleaning the surface. Do not use liquid or spray detergents for cleaning.
- Before connecting, make sure that the power supply voltage is correct. The device is connected to a power outlet which should be grounded connection.



The system may burn fingers while running.

Wait for 30 minutes to handle electronic parts after power off.

Chapter 1 - Introduction

► I/O Overview

KS156P-TGU

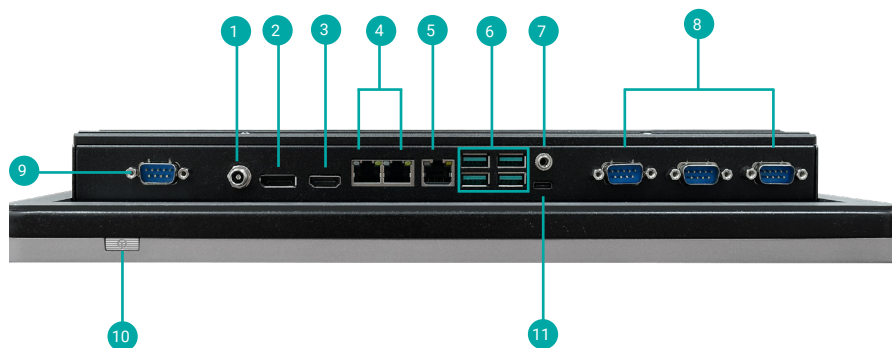

KS215P-TGU

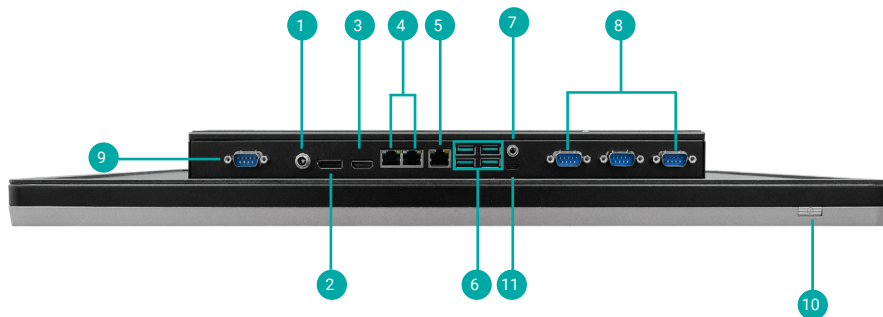

- | | |
|------------|-----------------|
| 1 DC-In | 6 USB 3.2 Gen2 |
| 2 DP++ | 7 Line-Out |
| 3 HDMI | 8 COM Ports 2~4 |
| 4 LAN | 9 COM1 |
| 5 2.5G LAN | 10 Power Button |
| | 11 USB Type-C |

► Dimensions

KS156P-TGU

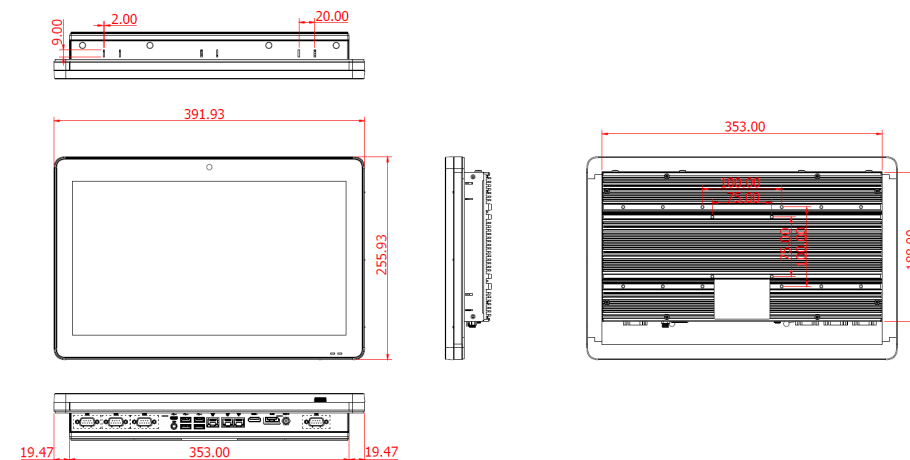

KS215P-TGU

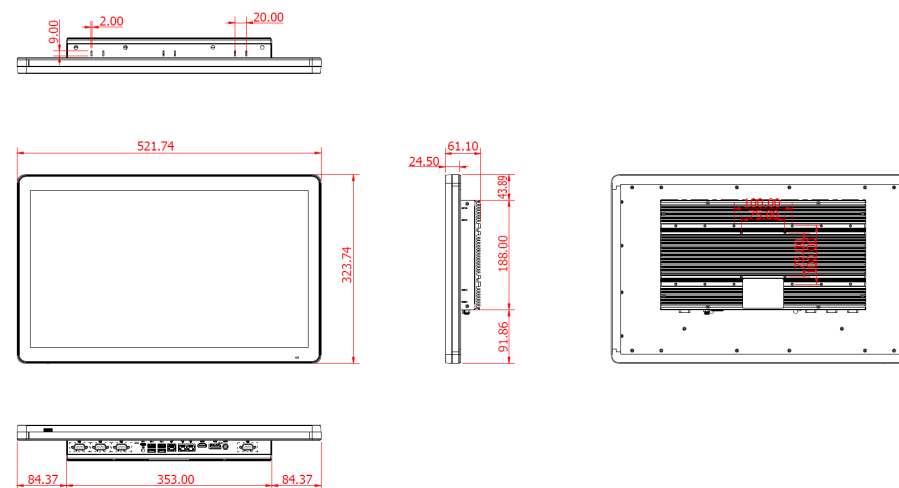

► **Key Features**

CPU Performance:

Intel® Core™ i5-1145GRE, Quad Core

Intel® Celeron® 6305E, Dual Core

Touch Type:

Projected Capacitive Touch

Dual Display:

HDMI & DP++

Multiple Expansions:

M.2 2242/2280 M Key

M.2 2242/3042/3052 B Key

M.2 2230 E Key

Wide Voltage:

Support 9 ~ 36V

► Specifications

DISPLAY AND TOUCH SCREEN	Display	KS156P-TGU: 15.6" TFT LCD Panel KS215P-TGU: 21.5" TFT LCD Panel
	Contrast	16 : 9
	Max. Resolution	1920 x 1080
	Touch Type	Projected Capacitive
	Brightness	KS156P-TGU: 400 (cd/m ²) KS215P-TGU: 300 (cd/m ²)
	Backlight Lifetime	50,000 (hours)
SYSTEM	Processor	Intel® Core™ i5-1145GRE, Quad Core, 8M Cache, 1.5GHz (4.1GHz), 15W Intel® Celeron® 6305E, Dual Core, 4M Cache, 1.8GHz (1.8GHz), 15W
	Memory	Two 260-pin SODIMM up to 64GB (32GB per slot) Dual channel DDR4 up to 3200MHz
	BIOS	AMI SPI 256Mbit
GRAPHICS	Controller	Intel® Iris® Xe Graphics for i7/i5 Processors Intel® UHD Graphics for i3/Celeron Processors
	Feature	OpenGL 4.5, DirectX 12, OpenCL 2.1 HW Decode: WMV9, AVC/H264, JPEG/MJPEG, HEVC/H265, VP9, AV1 HW Encode: AVC/H264, JPEG, HEVC/H265, VP9
	Display	1 x DP++ DP++: resolution up to 3840x2160 @ 60Hz 1 x HDMI 2.0 HDMI: resolution up to 3840x2160 @ 24Hz
	Dual Displays	DP++ + HDMI
STORAGE	External	1 x 2.5" SATA 3.0 Drive Bay
EXPANSION	Interface	1 x M.2 2242/2280 M Key (PCIe Gen4 x4) 1 x M.2 2242/3042/3052 B Key (PCIe Gen3 x1/SATA/USB 3.1 Gen1) 1 x M.2 2230 E Key (USB2.0)
I/O	Ethernet	2 x GbE 1 x 2.5GbE
	Serial	2 x RS-232/422/485 2 x RS-232
	USB	4 x USB 3.1 Gen2 1 x USB Type-C (Support USB 3.1 Gen2, 15W power delivery and DP Alt mode)
	Display	1 x DP++ 1 x HDMI
	Audio	1 x Line-Out
	Button	1 x Power Button

POWER	Type	DC 9-36V
	Connector	DC Jack
OS SUPPORT	Microsoft	Windows 10 IoT Enterprise 64bit
	Linux	Linux
MECHANISM	Construction	Plastic + Sheet Metal
	Mounting	VESA Mount 100 x 100
	IP Rating	IP65 Front Panel Protection Without Power Button
	Dimensions(W x H x D)	KS156P-TGU: 392 x 256 x 58.7 mm KS215P-TGU: 521.8 X 323.8 X 61.1 mm
	Weight	•KS156P-TGU Weight 4.5KG •KS215P-TGU Weight 7.4KG
ENVIRONMENT	Operating Temperature	0°C ~ 50°C
	Storage Temperature	-30°C ~ 80°C
	Relative Humidity	10 to 95% @ 40°C, non-condensing
STANDARDS AND CERTIFICATIONS	Shock	OP: Half-sine, 3G @ 11ms Non-OP: Half-sine, 5G @ 11ms
	Vibration	OP: Random, 1Grms @ 5~500Hz, 30min Non-OP: Sweep sine, 3Grms @ 10~500Hz, 30min
	Certifications	KS156P-TGU: CE, FCC, Class A KS215P-TGU: CE, FCC, Class A

Chapter 2 - Hardware Installations

► Removing the Chassis Cover

Please observe the following guidelines and follow the instructions to open the system.

1. Make sure the system and all other peripheral devices connected to it have been powered off.
2. Disconnect all power cords and cables.

Step 1:

The 8 screws of the system are used to secure the cover to the chassis. Remove the screws and put them in a safe place for later use.



Step 2:

Lift the cover to open the system.



► Installing a SSD Tray

The SSD Tray can be mounted with a 2.5" SATA SSD and secured onto the system board for storage. Please follow the steps below for the assembly.

1. Place the SATA SSD in between the SSD brackets while making sure the SATA connector can be access.

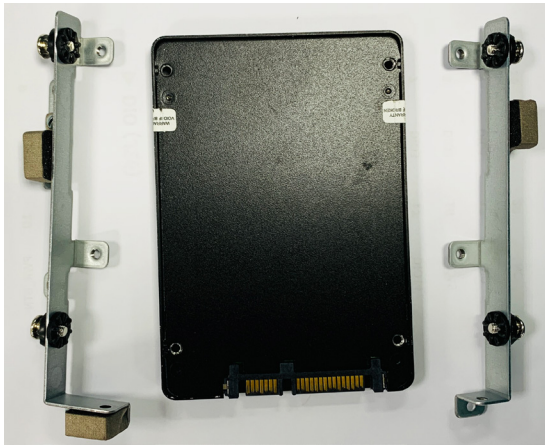

2. Screw in the four black screws from each bracket to secure a SSD in place.

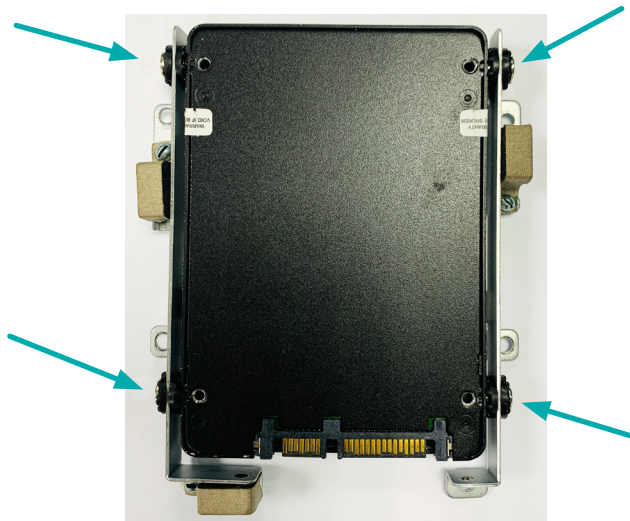

3. Screw in the four screws provided in the package to secure the SSD tray in place.

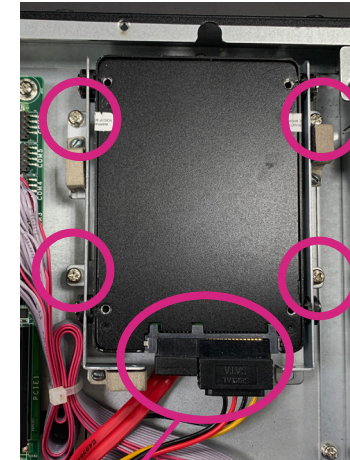
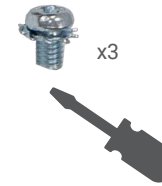

4. Connect the SATA cable and the SATA power cable to SSD and the board connectors.



Note:
After the SATA SSD is correctly mounted, please attach the bottom cover back on as previously instructed

► **Installing an M.2 Card**

Before installing the M.2 module into the M.2 socket, please make sure that the following safety cautions are well-attended.

1. Make sure the PC and all other peripheral devices connected to it has been powered down.
2. Disconnect all power cords and cables.
3. Locate the M.2 socket on the system board
4. Make sure the notch on card is aligned to the key on the socket.
5. Make sure the standoff screw is removed from the standoff.

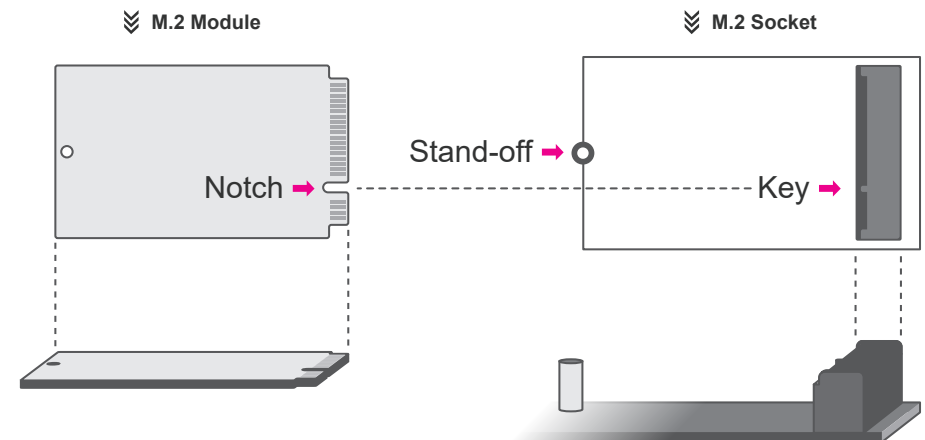
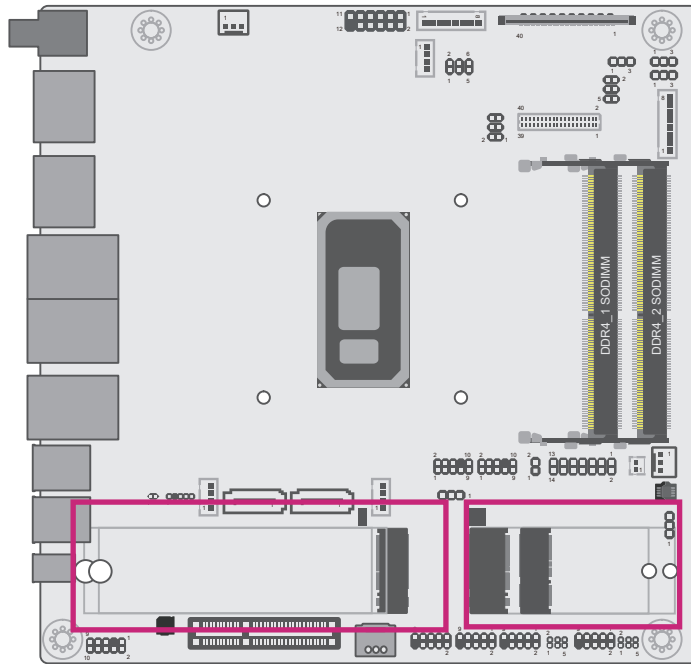

Please follow the steps below to install the card into the socket.

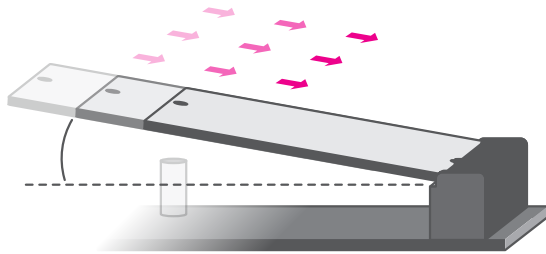

Step 1:
 Insert the card into the socket at an angle while making sure the notch and key are perfectly aligned.

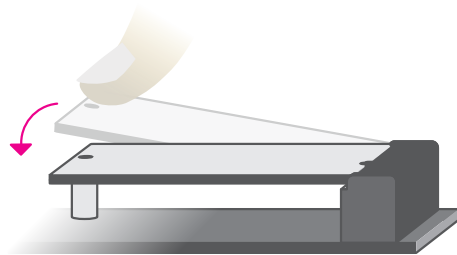

Step 2:
 Press the end of the card far from the socket down until against the stand-off.

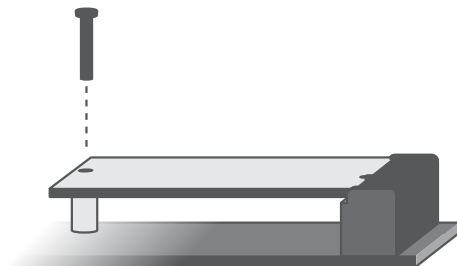

Step 3:
 Screw tight the card onto the stand-off with a screw driver and a stand-off screw until the gap between the card and the stand-off closes up. The card should be lying parallel to the board when it's correctly mounted.

► **Installing an Antenna**

Before installing the antenna, please make sure that the following safety cautions are well-attended.

1. Make sure the PC and all other peripheral devices connected to it has been powered down.
2. Disconnect all power cords and cables.

Step 1:
 There are antenna holes reserved on the rear side of the system and covered by rubber plugs. Please remove the plug prior to installing an antenna.



Step 2:
 Connect the internal cable to the board's antenna connector, screw the antenna connector through the antenna hole with washers and nuts, and screw on the antenna as illustrated below.

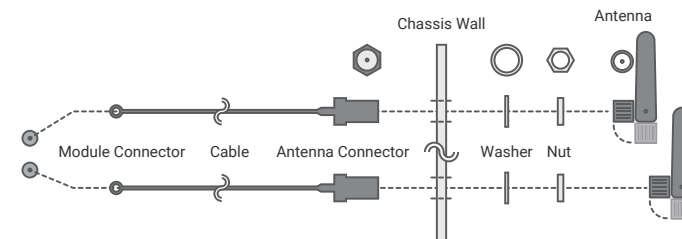

► Mounting Options

VESA Mount- KS156P-TGU

Step 1:

Select a place on the wall where you will mount the Panel PC.

Step 2:

Use the provided mounting screws to attach **wall mount bracket 1** onto the wall.

Step 3:

Attach the other bracket (**wall mount bracket 2**) to the rear of the Panel PC.

Step 4:

Slide the Panel PC to **wall mount bracket 1** and attach the two brackets together with the hooks. Then tighten the screw to secure the assembly in place.

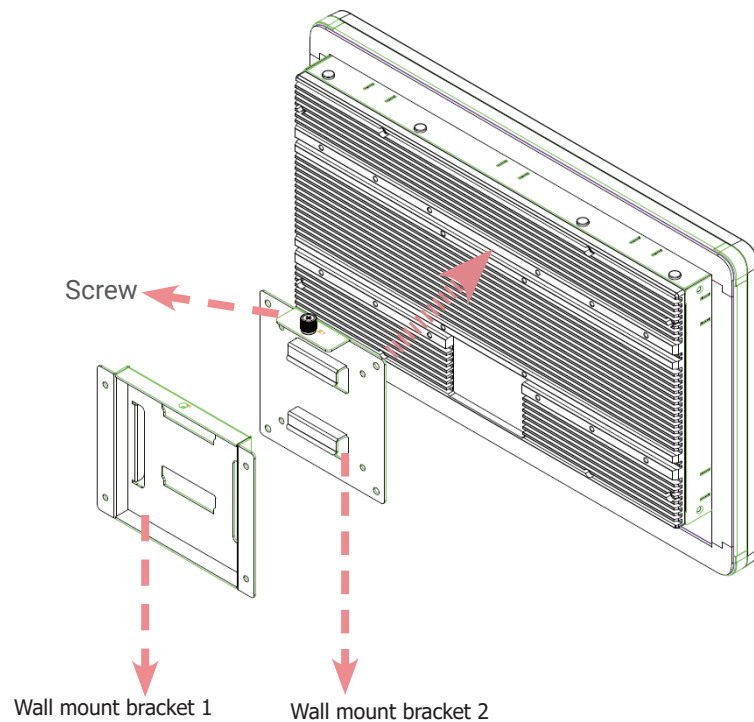

VESA Mount- KS215P-TGU

Step 1:

Select a place on the wall where you will mount the Panel PC.

Step 2:

Use the provided mounting screws to attach **wall mount bracket 1** onto the wall.

Step 3:

Attach the other bracket (**wall mount bracket 2**) to the rear of the Panel PC.

Step 4:

Slide the Panel PC to **wall mount bracket 1** and attach the two brackets together with the hooks. Then tighten the screw to secure the assembly in place.

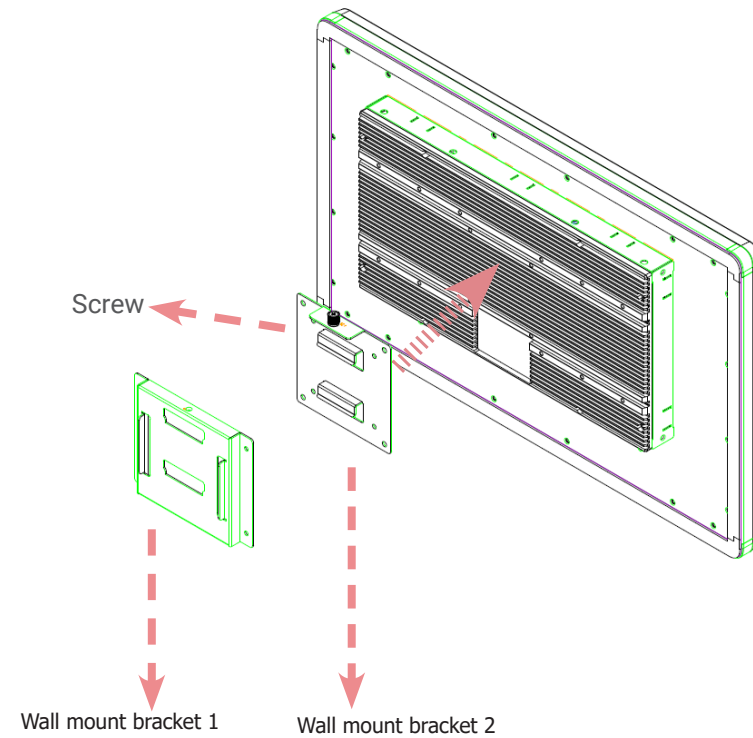

Panel Mount

Step 1:

Select a place on the panel (or wall) where you will mount the Panel PC.

Step 2:

Cut out a shape on the panel that corresponds to the Panel PC's rear dimensions (359mm x 194mm) and ensure that the Panel PC can be fitted into the panel properly.

The flat panel thickness is less than 3mm. Be sure to route or trim down the thick wall to 3 mm or slightly less for the clamps to recess and be compatible with your wall or enclosure.

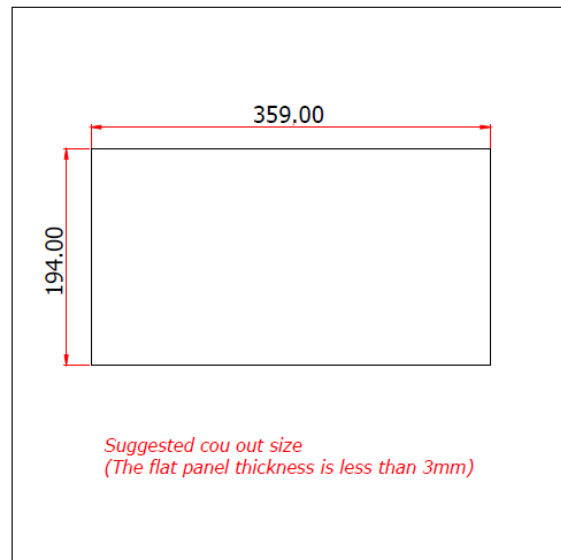

Step 3:

Insert the Panel PC from the outside surface of the panel into the mounting hole until it is properly fitted against the panel.

Step 4:

Position the mounting clamps along the rear edges of the Panel PC and insert them into the slits around the Panel PC.

Step 5:

The first and second clamps must be positioned and secured diagonally prior to mounting the rest of the clamps. Tighten the clamp's screw using an electric screwdriver by pressing the white plastic cap onto the back of the panel. The illustration below shows that all clamps are properly mounted.

Panel Mount - KS156P-TGU

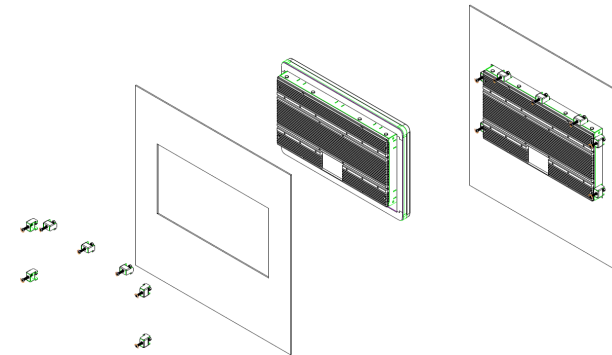

Panel Mount - KS215P-TGU

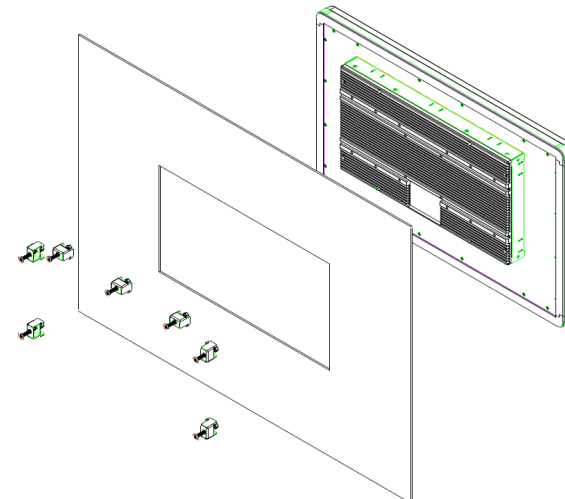

Chapter 3 - System Settings

► System Layout

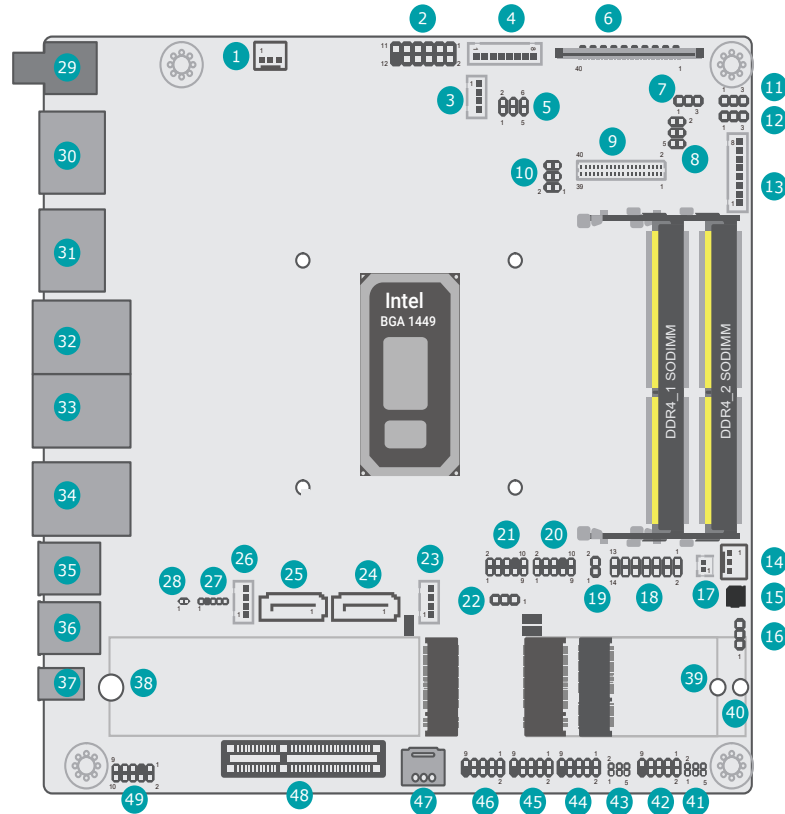

- | | |
|------------------------------|-----------------------|
| 1 CPU FAN | 13 LCD/Inverter Power |
| 2 Front Panel | 14 System FAN |
| 3 Digital I/O Power | 15 Buzzer |
| 4 Digital I/O | 16 Clear CMOS |
| 5 SMBus | 17 Battery |
| 6 eDP | 18 Debug Card |
| 7 eDP Inverter Power | 19 CASEOPEN- |
| 8 Panel Power Jumper | 20 USB 7/8 |
| 9 LVDS | 21 USB 5/6 |
| 10 Innoage HDR1 | 22 SATA Selection |
| 11 Panel Inverter Power | 23 SATA1 Power |
| 12 Panel Backlight Selection | 24 SATA1 |
| 25 SATA0 | 37 USB Type-C |
| 26 SATA0 Power | 38 M.2-M |
| 27 Debug | 39 M.2-E |
| 28 Debug | 40 M.2-B |
| 29 DC-in | 41 COM4 RS232 Power |
| 30 HDMI | 42 COM4 |
| 31 DP++ | 43 COM3 RS232 Power |
| 32 LAN1 | 44 COM3 |
| 33 LAN2 | 45 COM2 |
| 34 2.5G LAN1 | 46 COM1 |
| 35 USB 1/2 (USB 3.1 Gen2) | 47 SIM slot |
| 36 USB 3/4 (USB 3.1 Gen2) | 48 PCIe x4 |
| | 49 Front Audio |

► **Jumper Settings**

Clear CMOS (JP1)

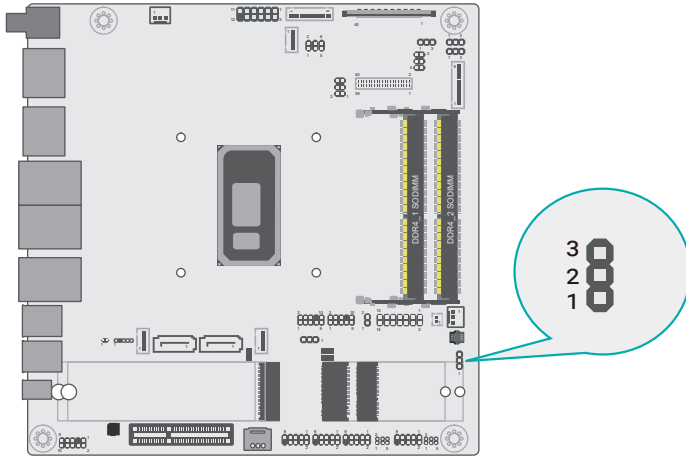

■ 1-2 On: Normal (default)



■ 2-3 On: Clear CMOS Data

COM 4 RS232 Power (JP3)

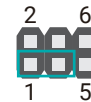
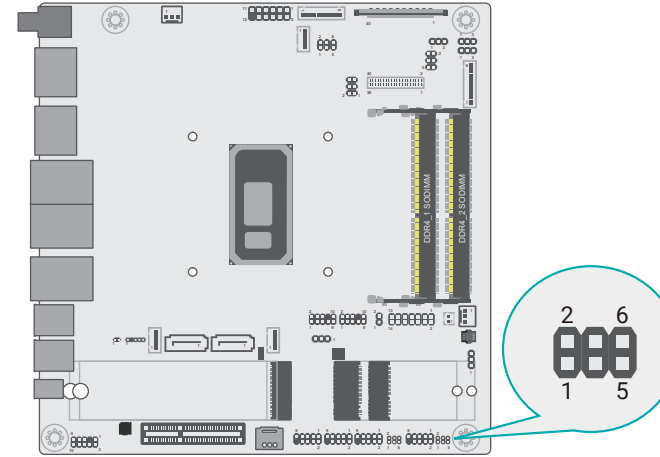

■ 1-3 On: Standard RS232 (default)

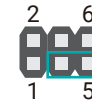

■ 3-5 On: RS232 with Power

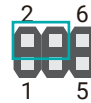

■ 2-4 On: Standard RS232(default)

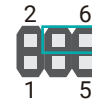

■ 4-6 On: RS232 with Power

COM 3 RS232 Power (JP2)

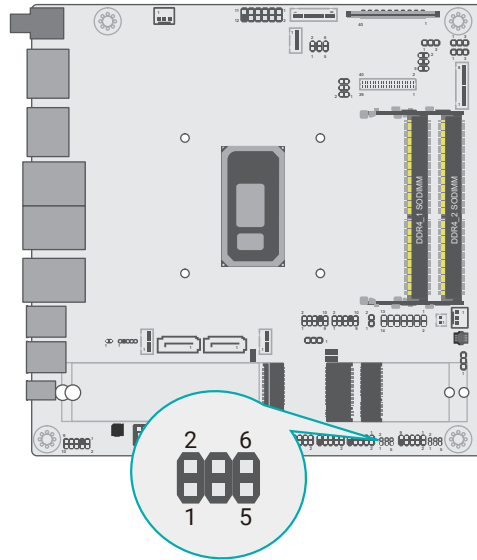

- 1-3 On: Standard RS232 (default)
 - 3-5 On: RS232 with Power
- 2-4 On: Standard RS232 (default)
 - 4-6 On: RS232 with Power

SATA Selection (JP8)

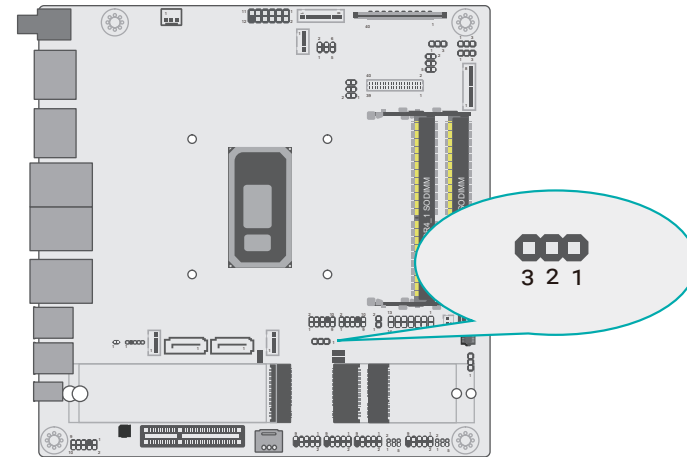

- 1-2 On: M.2 Key B (default)
 - 2-3 On: SATA1

It can be able to swap each function below in BIOS :

JP8	SATA0	SATA1	M.2_B KEY	
1-2	SATA0 (via PCIe11)	N/A	PCIe x1/SATA (controlled by M.2 Pin69)	USB3.0 (from PCIe Switch)
2-3	SATA0 (via PCIe11)	SATA1 (via PCIe12)	N/A	USB3.0 (from PCIe Switch)
1-2	N/A	N/A	PCIe x2 (via PCIe11/12)	

eDP Inverter Power (DPJP1)

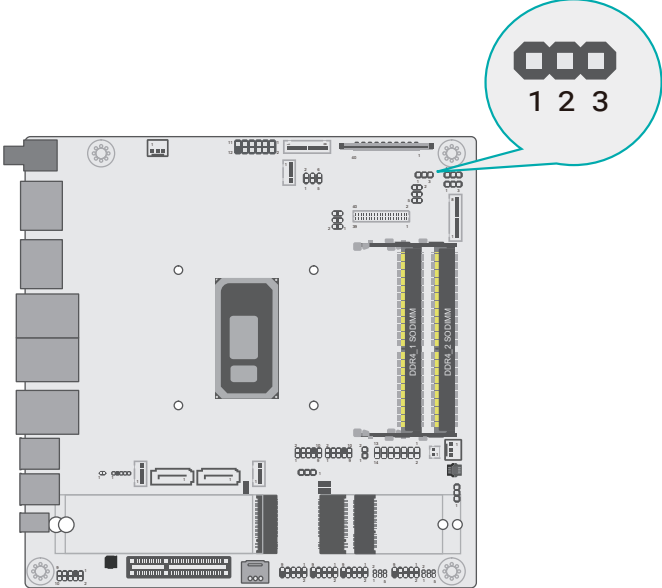

■ 1-2 On: +12V (default)



■ 2-3 On: 5V

Panel Inverter Power (DPJP2)

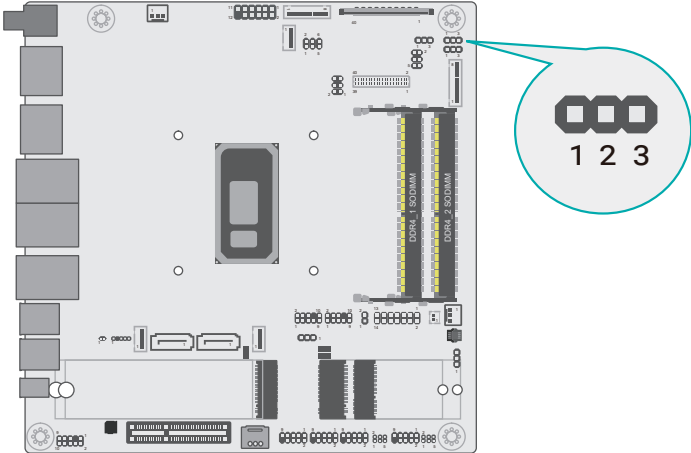

■ 1-2 On: 5V (default)



■ 2-3 On: 12V

Panel Power Jumper (DPJP3)

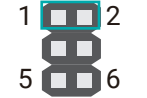
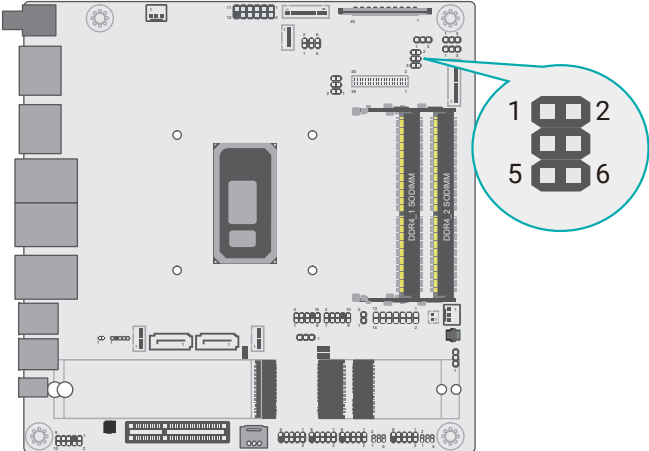

■ 1-2 On: 12V

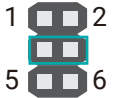

■ 3-4 On: 5V



■ 5-6 On: 3.3V (default)

Panel Backlight Selection (DPJP4)

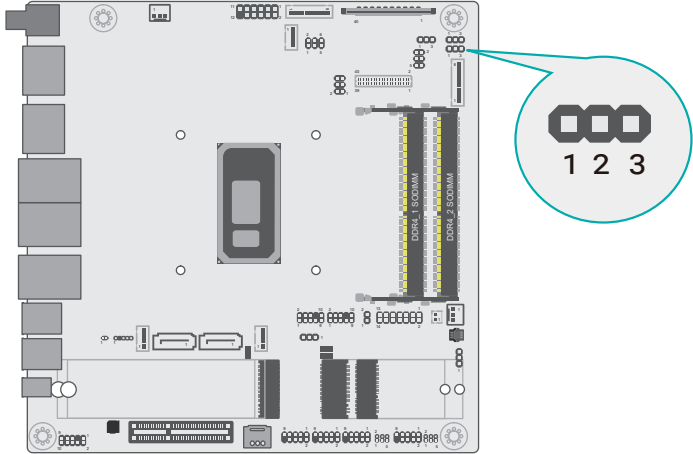

■ 1-2 On: 3.3V (default)



■ 2-3 On: 5V

► **PIN Assignment**

CASEOPEN-

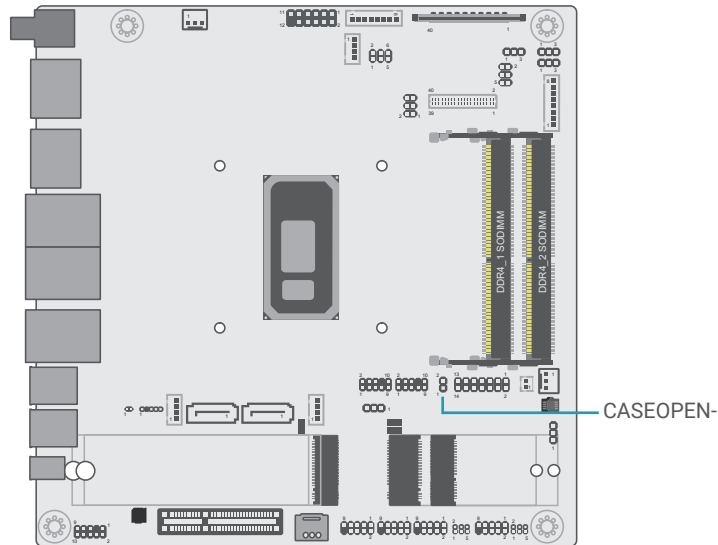

Pin	Function	Pin	Function
1	CASEOPEN-	2	GND

SMBus

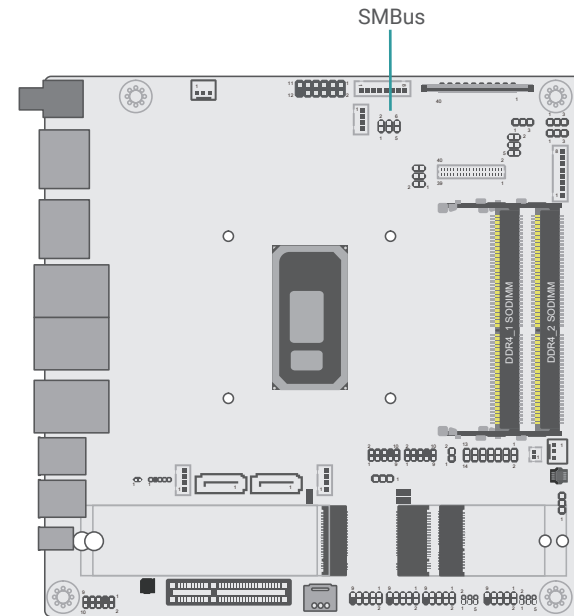

Pin	Assignment	Pin	Assignment
1	3V3SB	2	GND
3	SMB_CLK	4	SMB_DATA
5	SMB_ALERT	6	--

Digital I/O Power

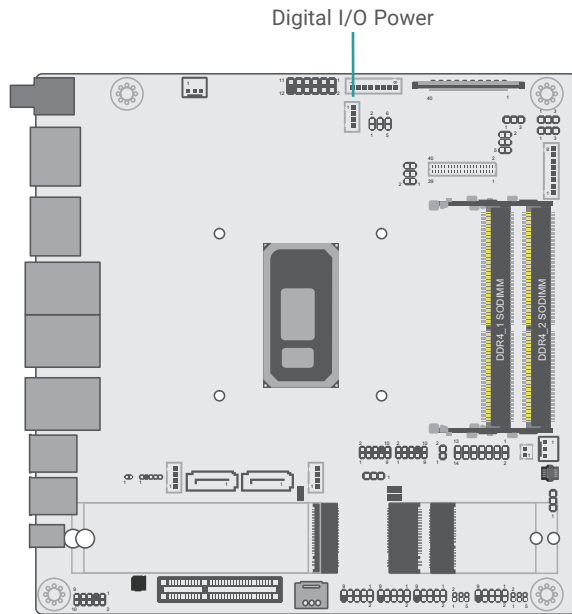

Pin	Function	Pin	Function
1	+12V	2	GND
3	5VSB	4	5V

Digital I/O

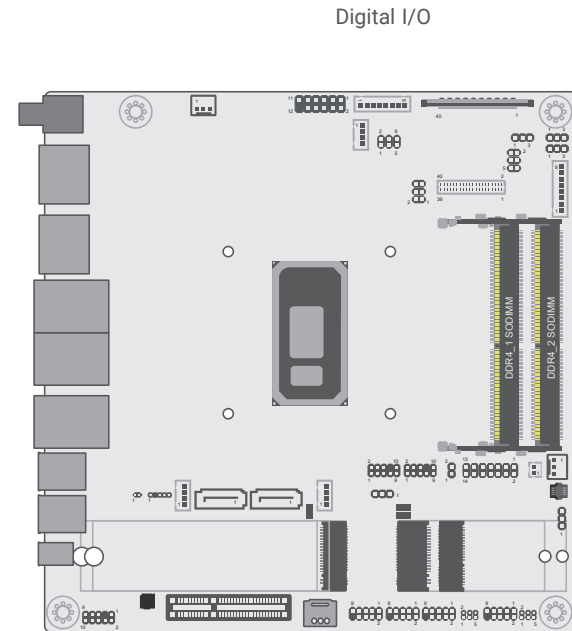

Pin	Function	Pin	Function
1	DIO_0	5	DIO_4
2	DIO_1	6	DIO_5
3	DIO_2	7	DIO_6
4	DIO_3	8	DIO_7

COM 1 & COM 2

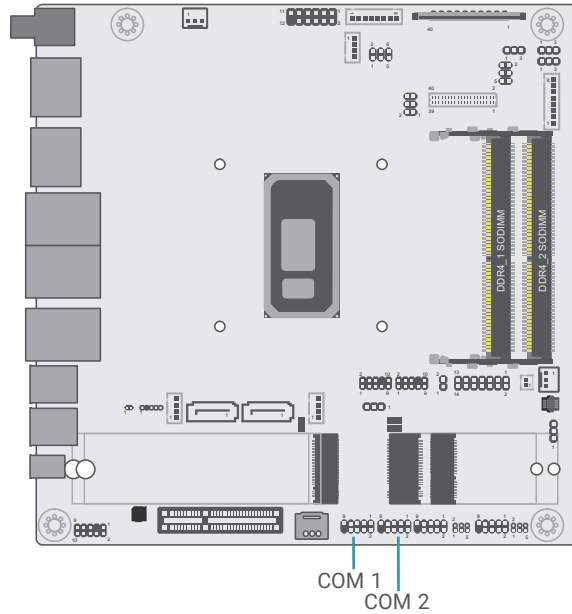

COM 3 & COM 4

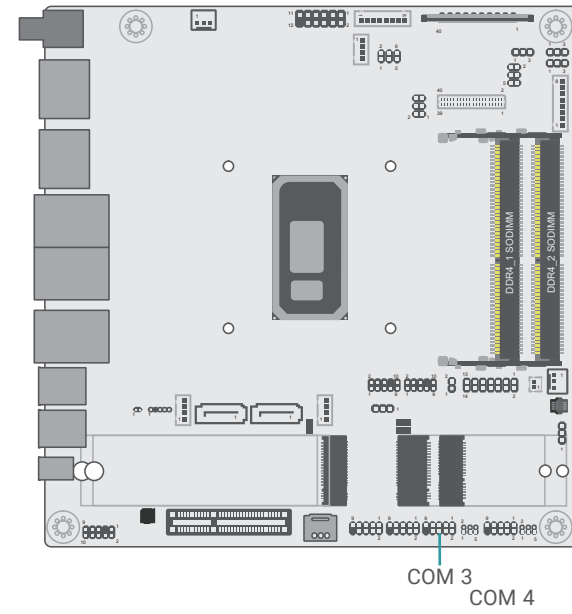

Pin	Function	Pin	Function
1	MDCD1(2)#	2	MSIN1(2)
3	MSOUT1(2)	4	MDTR1(2)#
5	GND	6	MDSR1(2)#
7	MRTS1(2)#	8	MCTS1(2)#
9	MRI1(2)#	10	--

	RS422/Half	RS422/Full	RS485
PIN 1 (DCD)		TX-	DATA-
PIN 2 (SIN)		TX+	DATA+
PIN 3 (SOUT)	RX+	RX+	
PIN 4 (DTR)	RX-	RX-	

Pin	Function	Pin	Function
1	X_MDCD3(4)#	2	MSIN3(4)#
3	MSO3(4)#	4	MDTR3(4)#
5	GND	6	MDSR3(4)#
7	MRTS3(4)#	8	MCTS3(4)#
9	X_MRI3(4)#	10	--

USB 5/6

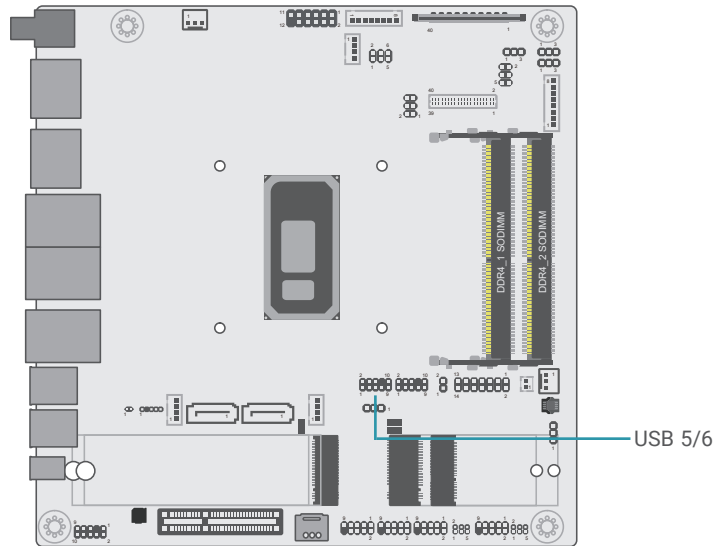

Pin	Assignment	Pin	Assignment
1	5V	2	5V
3	USB2_5_C_N	4	USB2_6_C_N
5	USB2_5_C_P	6	USB2_6_C_P
7	GND	8	GND
9	---	10	N.C.

USB 7/8

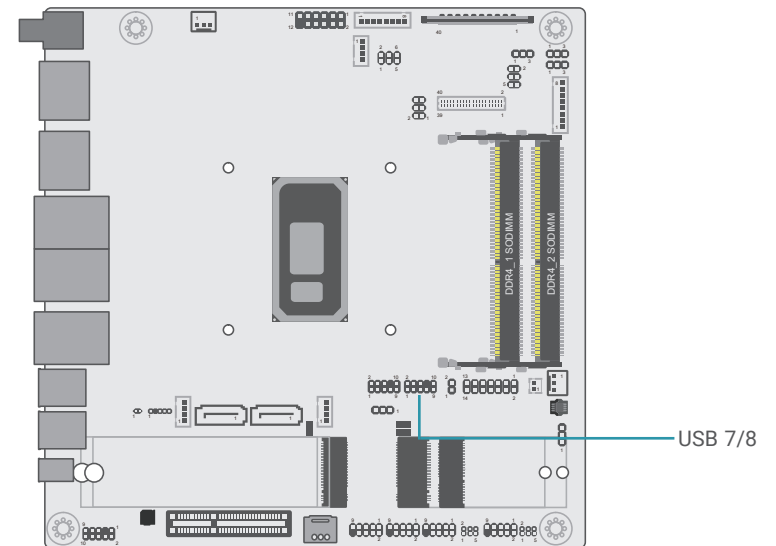

Pin	Assignment	Pin	Assignment
1	5V	2	5V
3	USB2_7_C_N	4	USB2_8_C_N
5	USB2_7_C_P	6	USB2_8_C_P
7	GND	8	GND
9	---	10	N.C.

SATA0/1 HDD Power

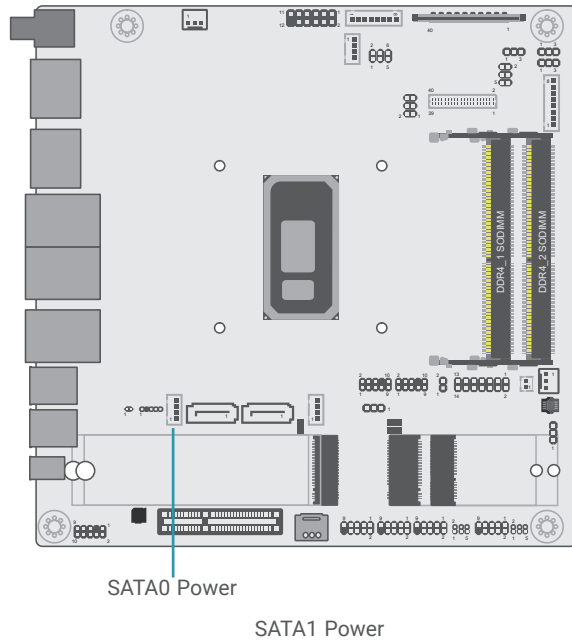

Pin	Assignment	Pin	Assignment
1	+12V_SATA	2	GND
3	GND	4	5V_SATA

Front Audio

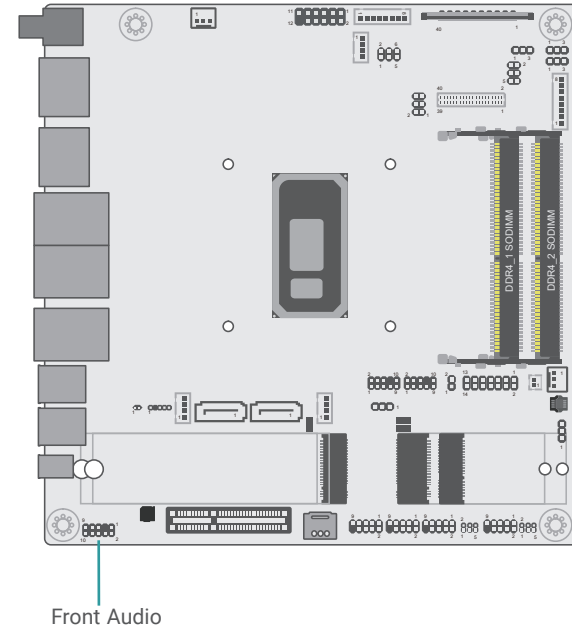

Pin	Assignment	Pin	Assignment
1	Mic2-L	2	GND
3	Mic2-R	4	N.C.
5	Line2-R	6	Mic2-JD
7	GND	8	---
9	Line2-L	10	Line2-JD

LCD/Inverter Power

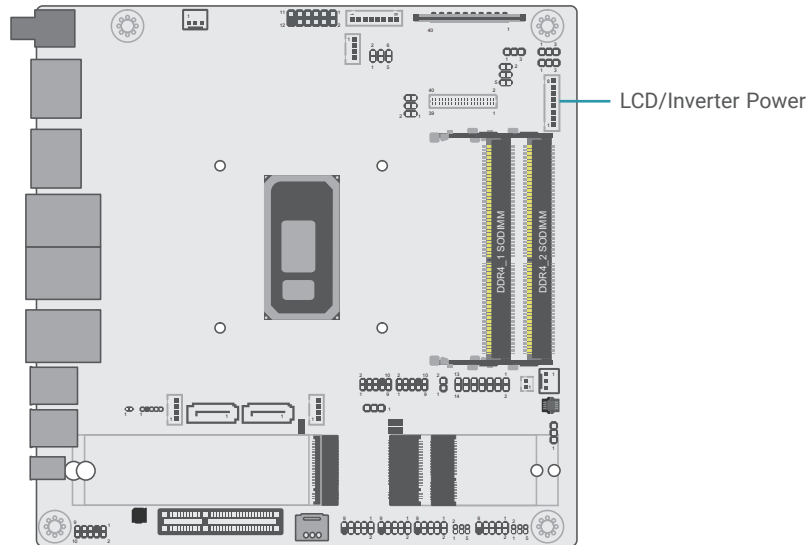

Pin	Assignment
1	GND
2	GND
3	Panel Inverter Brightness Voltage Control
4	Panel Power
5	+3.3V
6	Panel Backlight On/Off Control
7	12V / 5V (default)
8	12V / 5V (default)

LVDS

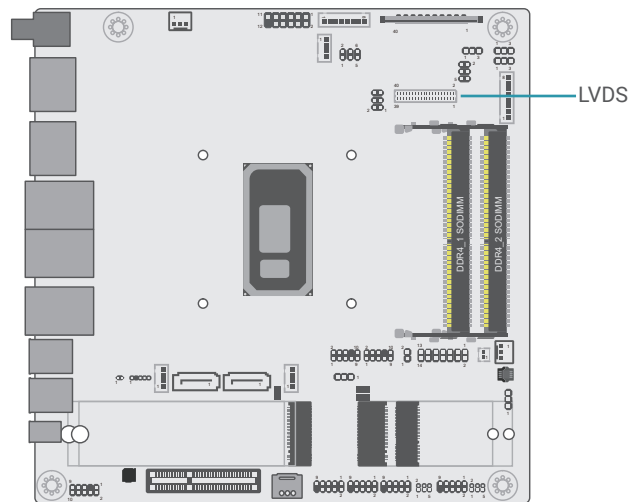

Pin	Assignment	Pin	Assignment
1	GND	2	GND
3	LVDS_A3+	4	LVDS_B3+
5	LVDS_A3-	6	LVDS_B3-
7	GND	8	GND
9	LVDS_A2+	10	LVDS_B2+
11	LVDS_A2-	12	LVDS_B2-
13	GND	14	GND
15	LVDS_A1+	16	LVDS_B1+
17	LVDS_A1-	18	LVDS_B1-
19	GND	20	GND
21	LVDS_A0+	22	LVDS_B0+
23	LVDS_A0-	24	LVDS_B0-
25	GND	26	GND
27	LVDS_CLK1+	28	LVDS_CLK2+
29	LVDS_CLK1-	30	LVDS_CLK2-
31	GND	32	GND
33	LVDS_DDC_CLK	34	NC
35	LVDS_DDC_DATA	36	+3.3V
37	Panel Power	38	Panel Power
39	Panel Power	40	Panel Power

eDP

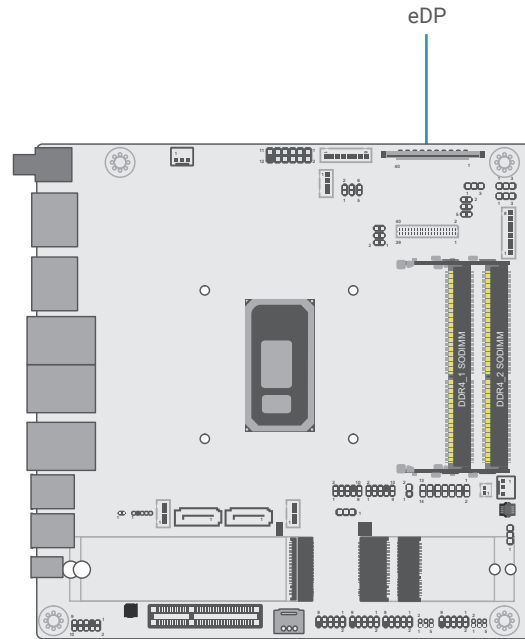

Pin	Assignment	Pin	Assignment
1	--	2	GND
3	eDPA_LANE3_C_N	4	eDPA_LANE3_C_P
5	GND	6	eDPA_LANE2_C_N
7	eDPA_LANE2_C_P	8	GND
9	eDPA_LANE1_C_N	10	eDPA_LANE1_C_P
11	GND	12	eDPA_LANE0_C_N
13	eDPA_LANE0_C_P	14	GND
15	eDPA_AUXP_C	16	eDPA_AUXN_C
17	GND	18	EDP_VDD
19	EDP_VDD	20	EDP_VDD
21	EDP_VDD	22	--
23	GND	24	GND
25	GND	26	GND
27	eDPA_HPD	28	GND
29	GND	30	GND
31	GND	32	EDP_BKLTEN
33	EDP_BKLTCTL	34	--
35	--	36	eDP_INV_PWR
37	eDP_INV_PWR	38	eDP_INV_PWR
39	eDP_INV_PWR	40	--

Chapter 4 - BIOS Settings

► Overview

The BIOS is a program that takes care of the basic level of communication between the CPU and peripherals. It contains codes for various advanced features found in this system board. The BIOS allows you to configure the system and save the configuration in a battery-backed CMOS so that the data retains even when the power is off. In general, the information stored in the CMOS RAM of the EEPROM will stay unchanged unless a configuration change has been made such as a hard drive replaced or a device added.

It is possible that the CMOS battery will fail causing CMOS data loss. If this happens, you need to install a new CMOS battery and reconfigure the BIOS settings.



Note:

The BIOS is constantly updated to improve the performance of the system board; therefore the BIOS screens in this chapter may not appear the same as the actual one. These screens are for reference purpose only.

Default Configuration

Most of the configuration settings are either predefined according to the Load Optimal Defaults settings which are stored in the BIOS or are automatically detected and configured without requiring any actions. There are a few settings that you may need to change depending on your system configuration.

Entering the BIOS Setup Utility

The BIOS Setup Utility can only be operated from the keyboard and all commands are keyboard commands. The commands are available at the right side of each setup screen.

The BIOS Setup Utility does not require an operating system to run. After you power up the system, the BIOS message appears on the screen and the memory count begins. After the memory test, the message "Press DEL to run setup" will appear on the screen. If the message disappears before you respond, restart the system or press the "Reset" button. You may also restart the system by pressing the <Ctrl> <Alt> and keys simultaneously.

Legends

Keys	Function
Right / Left arrow	Move the highlight left or right to select a menu
Up / Down arrow	Move the highlight up or down between submenus or fields
<Enter>	Enter the highlighted submenu
+ (plus key)/F6	Scroll forward through the values or options of the highlighted field
- (minus key)/F5	Scroll backward through the values or options of the highlighted field
<F1>	Display general help
<F2>	Display previous values
<F7>	Popup Boot Device List
<F9>	Optimized defaults
<F10>	Save and Exit
<Esc>	Return to previous menu

Scroll Bar

When a scroll bar appears to the right of the setup screen, it indicates that there are more available fields not shown on the screen. Use the up and down arrow keys to scroll through all the available fields.

Submenu

When "►" appears on the left of a particular field, it indicates that a submenu which contains additional options are available for that field. To display the submenu, move the highlight to that field and press <Enter>.

► Main

The Main menu is the first screen that you will see when you enter the BIOS Setup Utility.

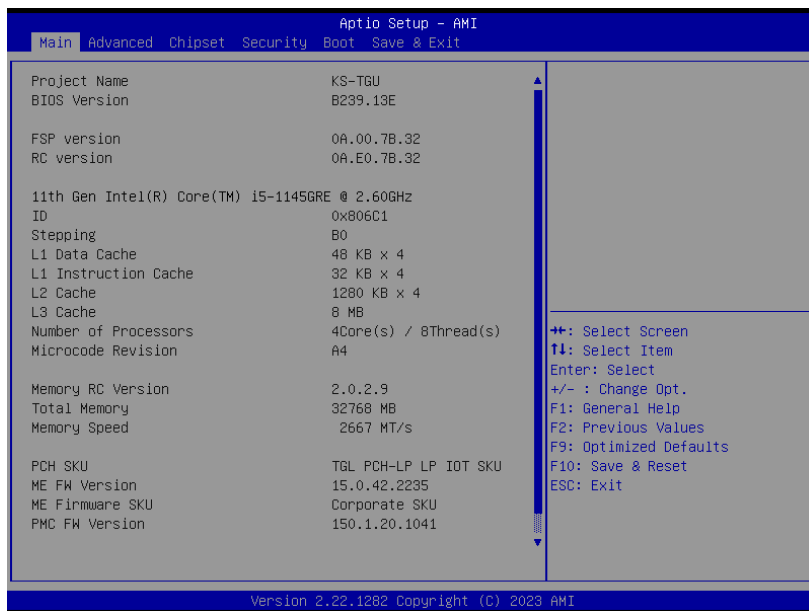

System Date

The date format is <month>, <date>, <year>. Press "Tab" to switch to the next field and press "-" or "+" to modify the value.

System Time

The time format is <hour>, <minute>, <second>. The time is based on the 24-hour military-time clock. For example, 1 p.m. is 13:00:00. Hour displays hours from 00 to 23. Minute displays minutes from 00 to 59. Second displays seconds from 00 to 59.

► Advanced

The Advanced menu allows you to configure your system for basic operation. Some entries are defaults required by the system board, while others, if enabled, will improve the performance of your system or let you set some features according to your preference.

 **Important:** Setting incorrect field values may cause the system to malfunction.

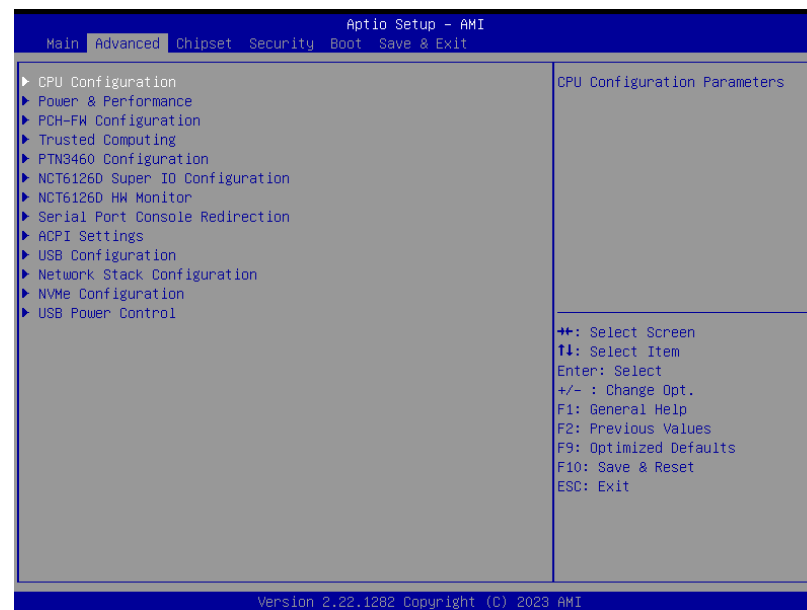

▶ Advanced

CPU Configuration

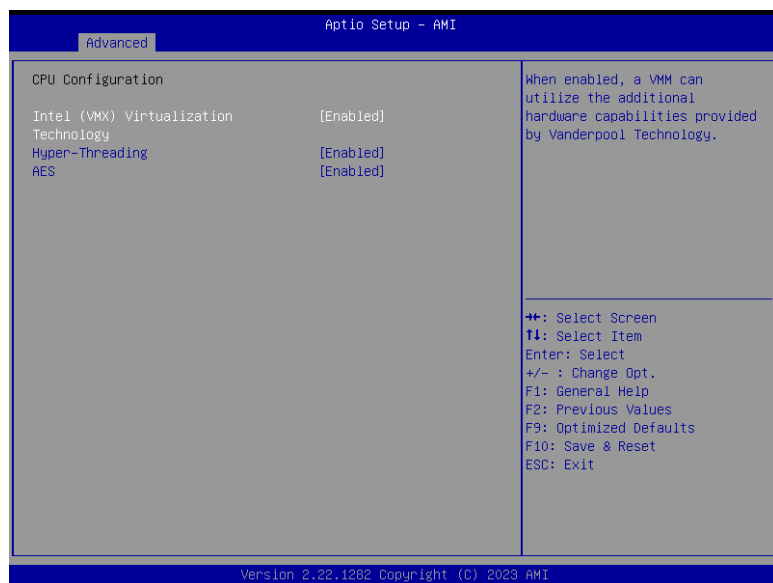

Intel (VMX) Virtualization Technology

When this field is set to **Enabled**, the VMM can utilize the additional hardware capabilities provided by Vanderpool Technology.

Hyper-threading

Enables this field for Windows XP and Linux which are optimized for Hyper-Threading technology. Select disabled for other OSes not optimized for Hyper-Threading technology. When disabled, only one thread per enabled core is enabled.

AES

Enable / Disable AES (Advanced Encryption Standard)

▶ Advanced

Power & Performance



▶ Advanced

Power & Performance ▶ CPU- Power Management Control

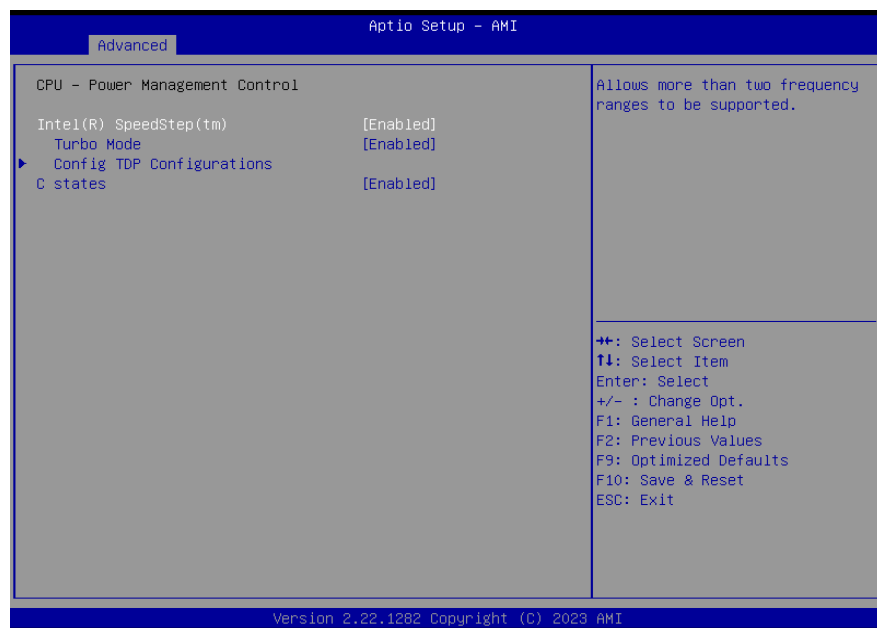

Intel (R) SpeedStep(tm)

This field is used to enable or disable the Intel SpeedStep® Technology, which helps optimize the balance between system's power consumption and performance. After it is enabled in the BIOS, EIST features can then be enabled via the operating system's power management.

Turbo Mode

Enable or disable turbo mode of the processor. This field will only be displayed when EIST is enabled.

C states

Enable or disable CPU Power Management. It allows CPU to enter "C states" when it's idle and nothing is executing.

▶ Advanced

PCH-FW Configuration

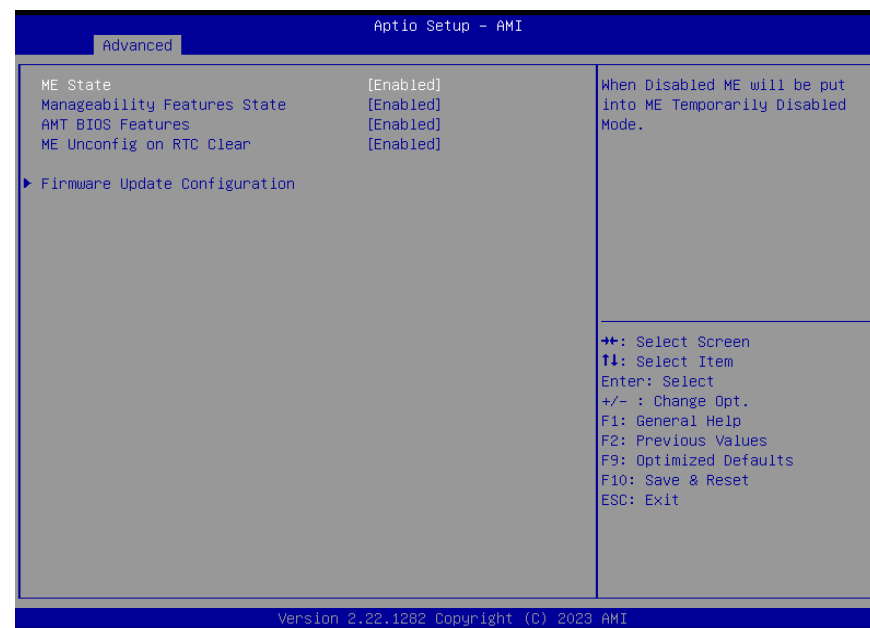

ME State

When this field is set to Disabled, ME will be put into ME Temporarily Disabled Mode.

Manageability Features State

Enable or disable Intel(R) Manageability features. This option disables/enables Manageability Features support in FW. To disable, support platform must be in an unprovisioned state first.

AMT BIOS Features

When disabled, AMT BIOS features are no longer supported and user is no longer able to access MEBx Setup. This option does not disable manageability features in FW.

ME Unconfig on RTC Clear

When Disabled ME will not be unconfigured on RTC Clear.

Firmware Update Configuration

Configure Management Engine Technology Parameters.

▶ Advanced

Trusted Computing



Security Device Support

This field is used to enable or disable BIOS support for the security device such as an TPM 2.0 to achieve hardware-level security via cryptographic keys.

Pending operation

To clear the existing TPM encryption, select "TPM Clear" and restart the system. This field is not available when "Security Device Support" is disabled.



Note:
The sub-menus are detailed in following sections.

▶ Advanced

PTN3460 Configuration

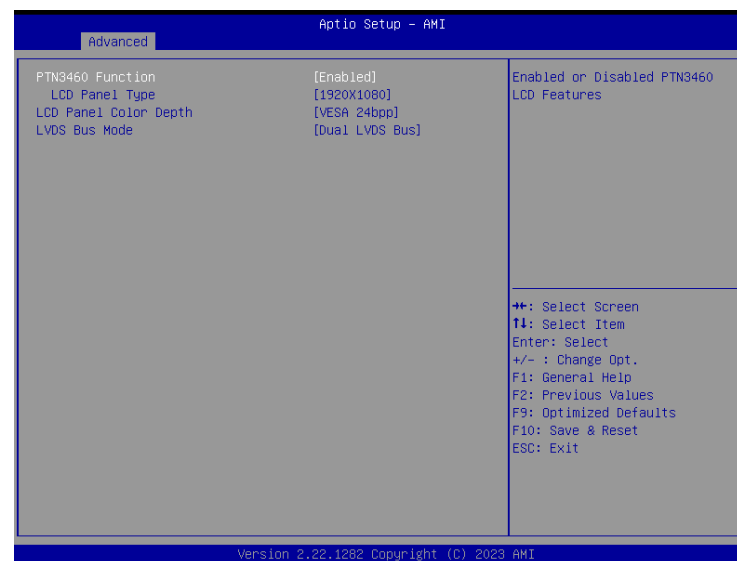

PTN3460 Function

Enable or Disable PTN3460 LCD Features. When this field is disabled, the following fields will remain hidden.

LCD Panel Type

Select the resolution of the LCD Panel – 800X480, 800X600, 1024X768, 1366X768, 1280X1024, 1920X1080, or 1920X1200.

LCD Panel Color Depth

Select the color depth of the LCD Panel – VESA 24bpp, JEIDA 24bpp, VESA and JEIDA 18 bpp.

LVDS Bus Mode

Select PTN3460 LVDS BUS Mode : Single LVDS Bus /Dual LVDS Bus



Note:
The configuration must match the specifications of your LCD Panel in order for the LCD Panel to display properly.

► Advanced

NCT6126D Super IO Configuration

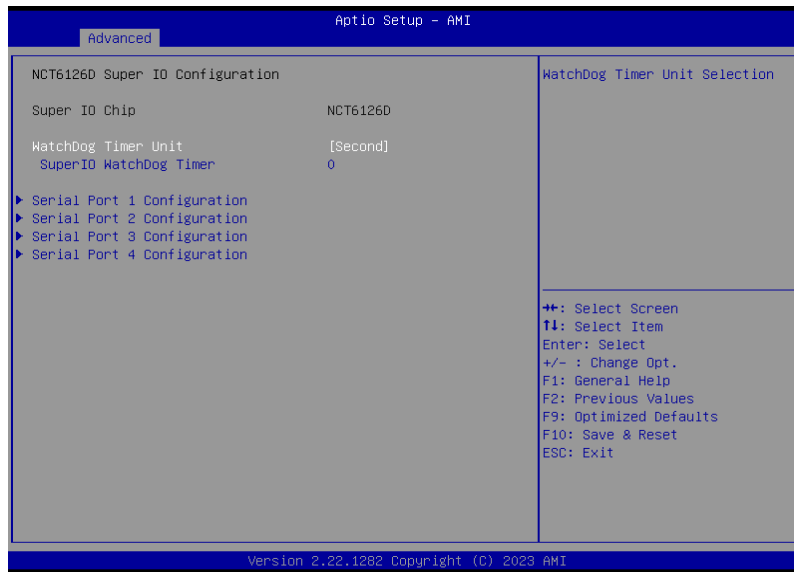

WatchDog Timer Unit

Select WatchDog Timer Unit – Second or Minute.

SuperIO WatchDog Timer

Set SuperIO WatchDog Timer Timeout value. The range is from 0 (disabled) to 255.



Note:
The sub-menus are detailed in following sections.

► Advanced

NCT6126D Super IO Configuration ► Serial Port 1, 2 Configuration

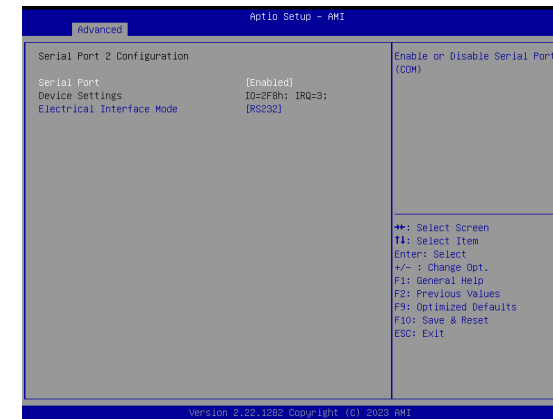

Serial Port

Enable or disable serial port.

Electrical Interface Mode

Select an optimal settings for Super IO Device.

▶ Advanced

NCT6126D Super IO Configuration ▶ Serial Port 3, 4 Configuration

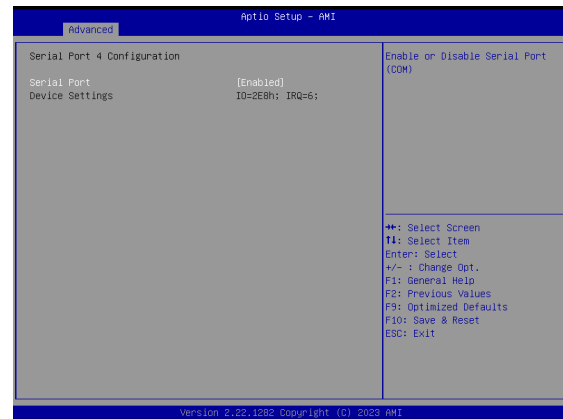

Serial Port

Enable or disable serial port.

▶ Advanced

NCT6126D HW Monitor

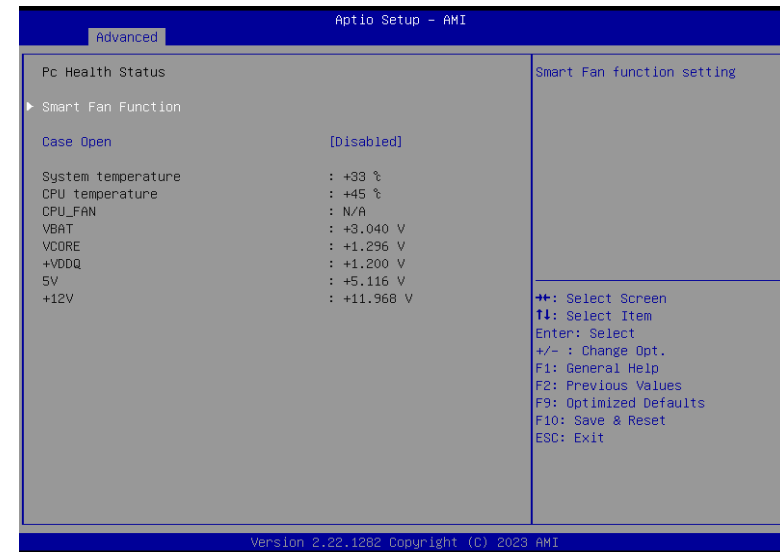

Smart Fan Function

Smart Fan Function Setting.

Case Open

Enable or disable the case open detection function.

▶ Advanced

NCT6126D HW Monitor ▶ Smart FAN Function

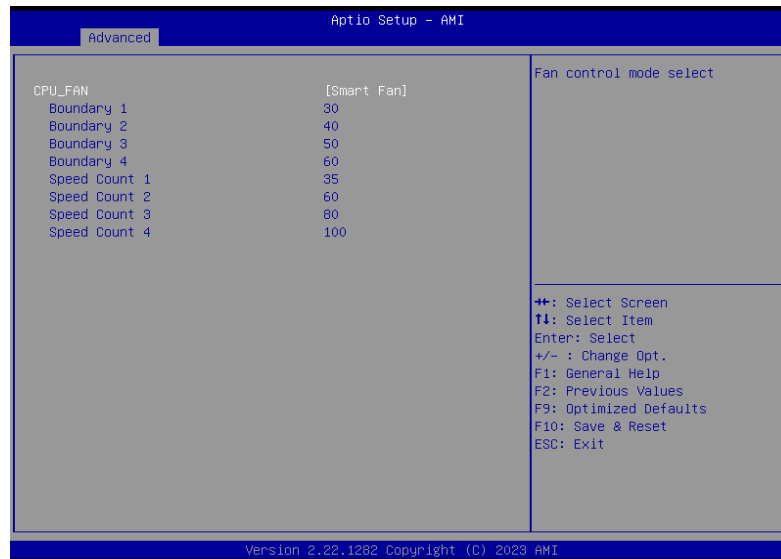

▼ CPU Fan Mode = [Smart Fan]

Boundary 1 to Boundary 4

Set the boundary temperatures that determine the fan speeds accordingly, the value ranging from 0-127°C. For example, when the system temperature reaches Boundary 1 setting, the fan speed will be turned up to the designated speed of the Fan Speed Count 1 field.

Fan Speed Count 1 to Fan Speed Count 4

Set the fan speed, the value ranging from 1-100%, 100% being full speed. The fans will operate according to the specified boundary temperatures above-mentioned.

▼ CPU Fan Mode = [Manual Mode]

Fix Fan Speed Count

Set the fan speed, the value ranging from 1-100%, 100% being full speed. The fans will always operate at the specified speed regardless of gauged temperatures.

▶ Advanced

Serial Port Console Redirection

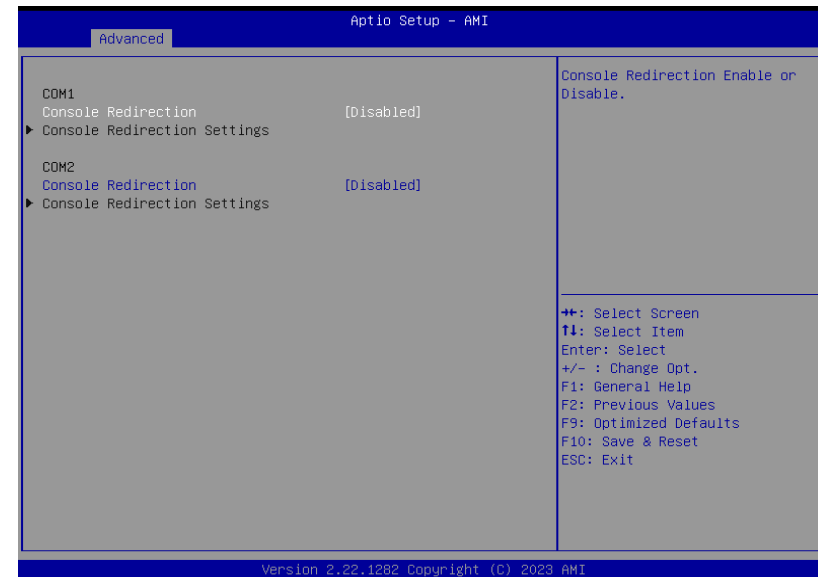

Console Redirection

By enabling Console Redirection of a COM port, the sub-menu of console redirection settings will become available for configuration as detailed in the following.

▶ Advanced

Serial Port Console Redirection ▶ Console Redirection Settings

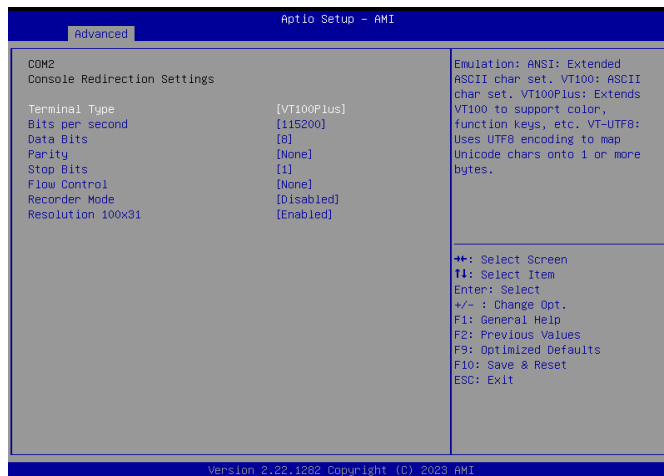

▶ Advanced

Terminal Type

Select terminal type: VT100, VT100+, VT-UTF8 or ANSI.

Bits per second

Select serial port transmission speed: 9600, 19200, 38400, 57600 or 115200.

Data Bits

Select data bits: 7 bits or 8 bits.

Parity

Select parity bits: None, Even, Odd, Mark or Space.

Stop Bits

Select stop bits: 1 bit or 2 bits.

Flow Control

Select flow control type: None or Hardware RTS/CTS. Flow Control is for RS485 mode.

Recorder Mode

With this mode enabled only text will be sent. This is to capture Terminal data.

Resolution 100x31

Enables or disables extended terminal resolution

▶ Advanced

ACPI Settings

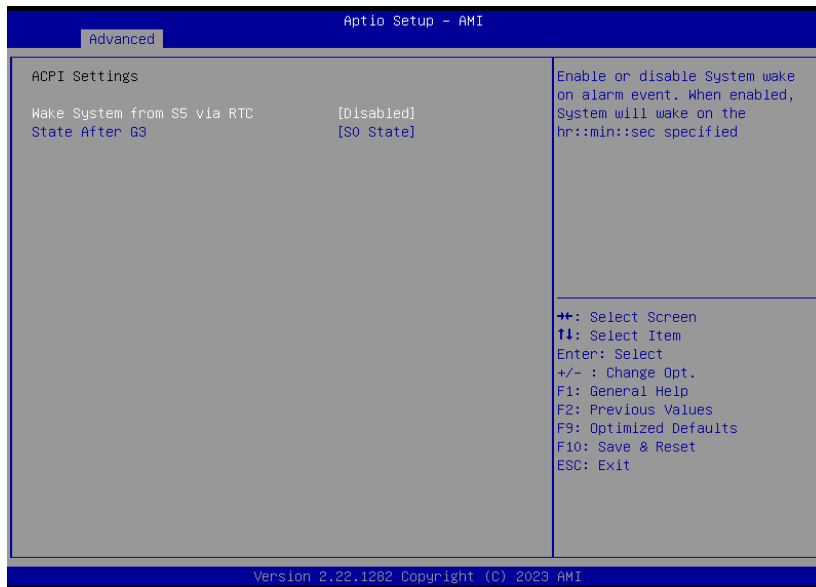

Wake system from S5 via RTC

When Enabled, the system will automatically power up at a designated time every day. Once it's switched to [Enabled], please set up the time of day – hour, minute, and second – for the system to wake up.

State After G3

Select between S0 State, and S5 State. This field is used to specify what state the system is set to return to when power is re-applied after a power failure (G3 state).

- **S0 State** The system automatically powers on after power failure.
- **S5 State** The system enter soft-off state after power failure. Power-on signal input is required to power up the system.
- **Last State** The system returns to the last state right before power failure.

▶ Advanced

USB Configuration

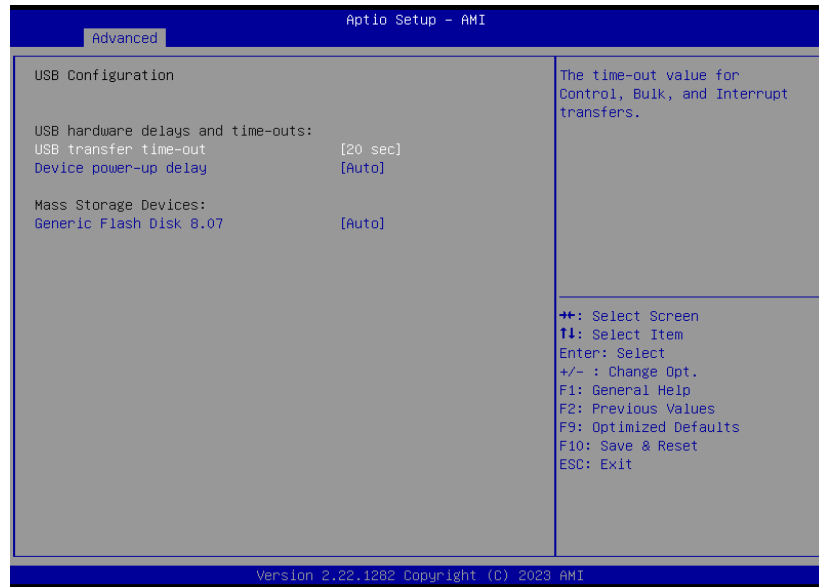

USB hardware delays and time-outs

- **USB transfer time-out** The time-out value for **Control**, **Bulk**, and **Interrupt transfers**.
- **Device power-up delay** Maximum time the device will take before it properly reports itself to the Host Controller. 'Auto' uses default value: for a Root port it is 100 Ms, for a Hub port the delay is taken from Hub descriptor.

▶ Advanced

Network Stack Configuration

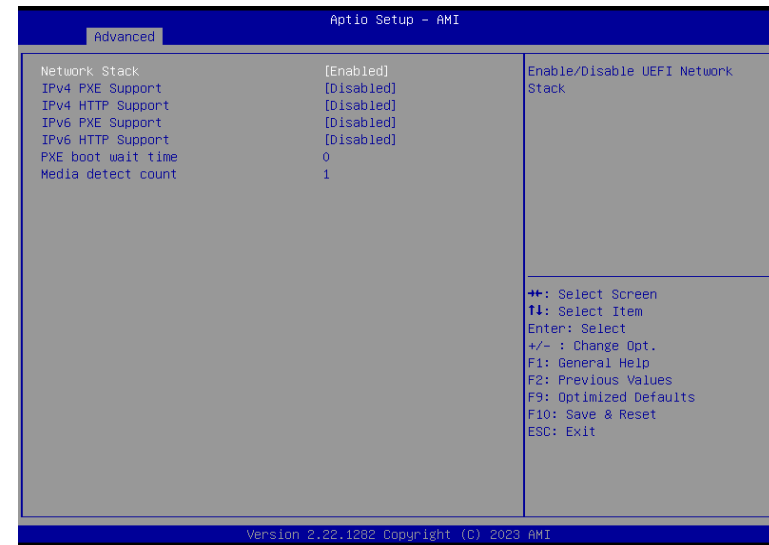

Network Stack

Enable or disable UEFI network stack. The following fields will appear when this field is enabled.

Ipv4 PXE Support

Enable or disable IPv4 PXE boot support. If disabled, IPv4 PXE boot support will not be available.

Ipv4 HTTP Support

Enable or disable IPv4 HTTP boot support. If disabled, IPv4 HTTP boot support will not be available.

Ipv6 PXE Support

Enable or disable IPv6 PXE boot support. If disabled, IPv6 PXE boot support will not be available.

Ipv6 HTTP Support

Enable or disable IPv6 HTTP boot support. If disabled, IPv6 HTTP boot support will not be available.

PXE boot wait time

Set the wait time in seconds to press ESC key to abort the PXE boot. Use either +/- or numeric keys to set the value.

Media detect count

Set the number of times the presence of media will be checked. Use either +/- or numeric keys to set the value.

▶ Advanced

NVMe Configuration

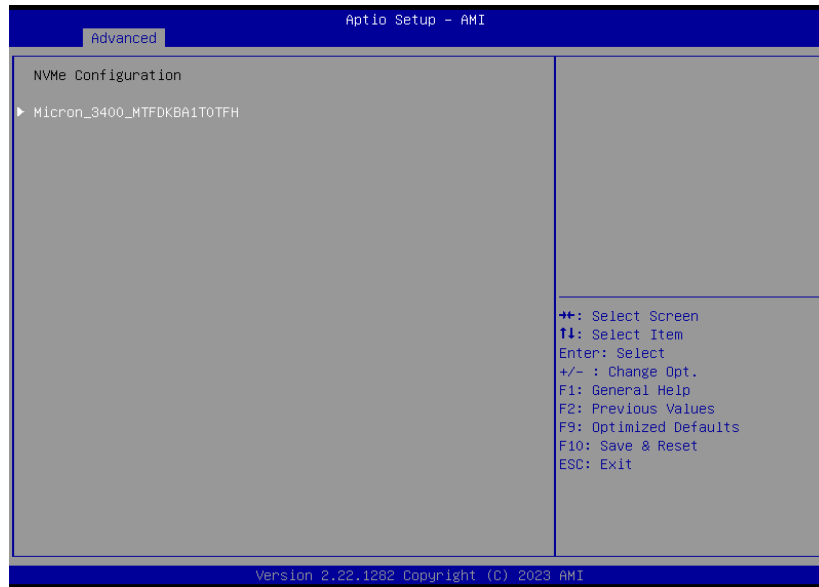

▶ Advanced

USB Power Control

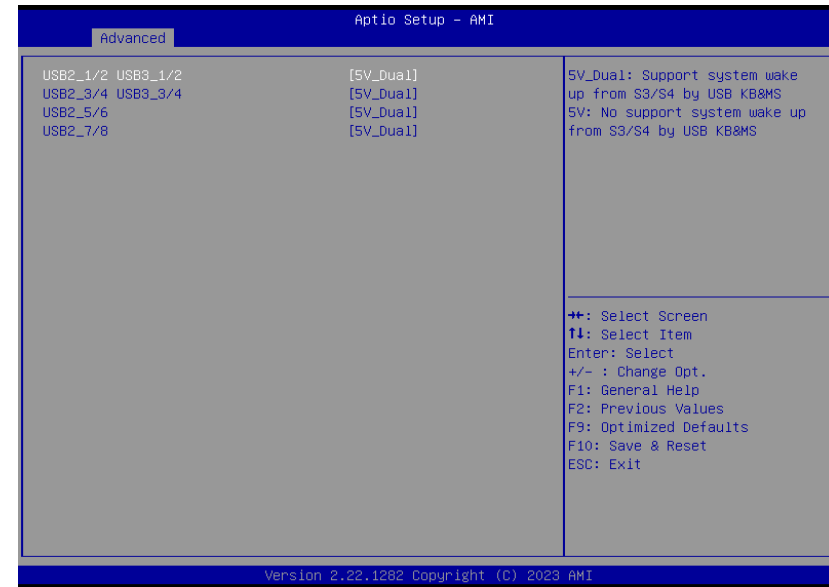

Server CA Configuration

5_Dual: Support system wake up from S3/S4 by USB KB&MS

5V: No support system wake up from S3/S4 by USB KB&MS

► Chipset



Please select a submenu and press Enter. The submenus are detailed in the following pages.

► Chipset

System Agent (SA) Configuration

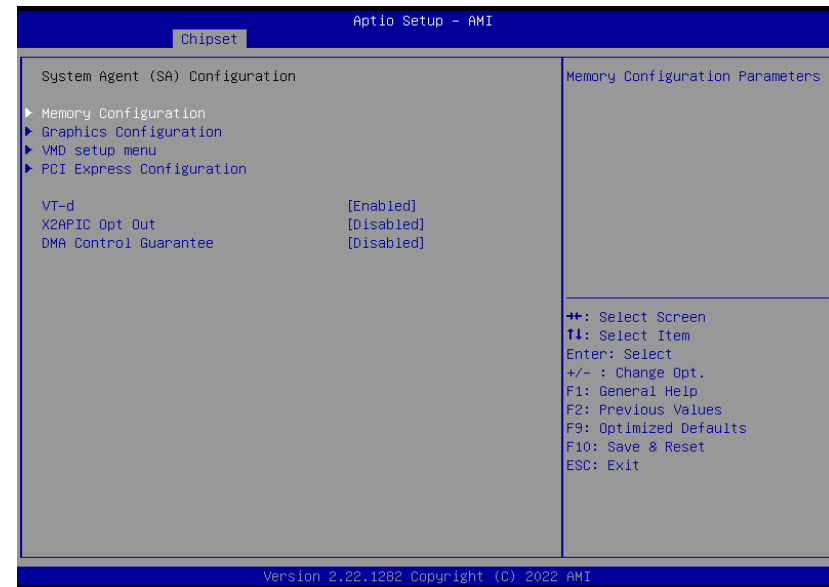

Memory Configuration

Memory Configuration Parameter.

Graphics Configuration

Settings about graphic.

VMD setup menu

VMD Configuration Settings

PCI Express Configuration :

VT-d

VT-d capability.

X2APIC Opt Out

Enable/Disable X2APIC_OPT_OUT bit

DMA Control Guarantee

Enable/Disable DMA_Control_Guarantee bit

► Chipset



Please select a submenu and press Enter. The submenus are detailed in the following pages.

► Chipset

System Agent (SA) Configuration

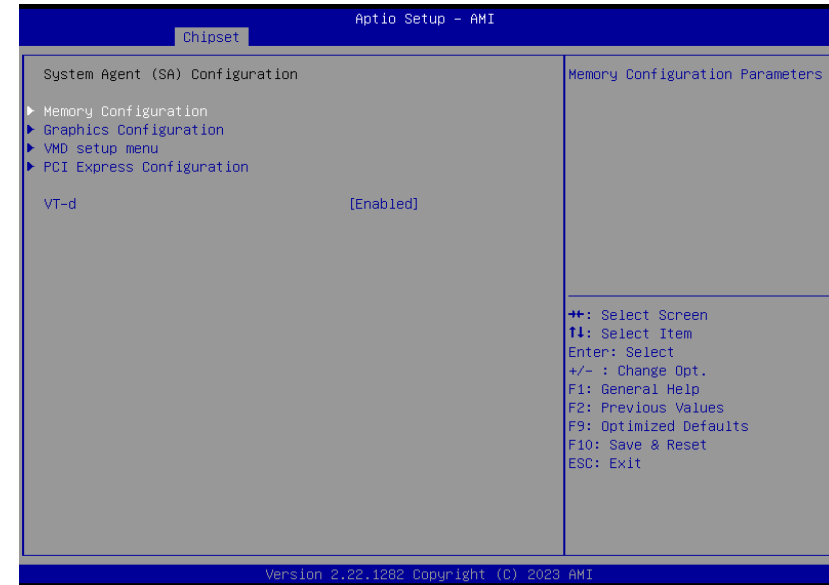

Graphics Configuration

Graphics Configuration

VMD setup menu

VMD Configuration Settings

PCI Express Configuration :

VT-d

VT-d capability.

► Chipset

PCH-IO Configuration



PCI Express Configuration

PCI Express Configuration Settings

SATA Configuration

SATA Device Options Settings

HD Audio Configuration

HD Audio Subsystem Configuration Settings

► Chipset

PCH-IO Configuration ► PCI Express Configuration



Select one of the PCI Express channels and press enter to configure the following settings.

LAN3, PCIE1, M.2-B

Control the PCI Express Root Port.

► Chipset

PCH-IO Configuration ► SATA Configuration

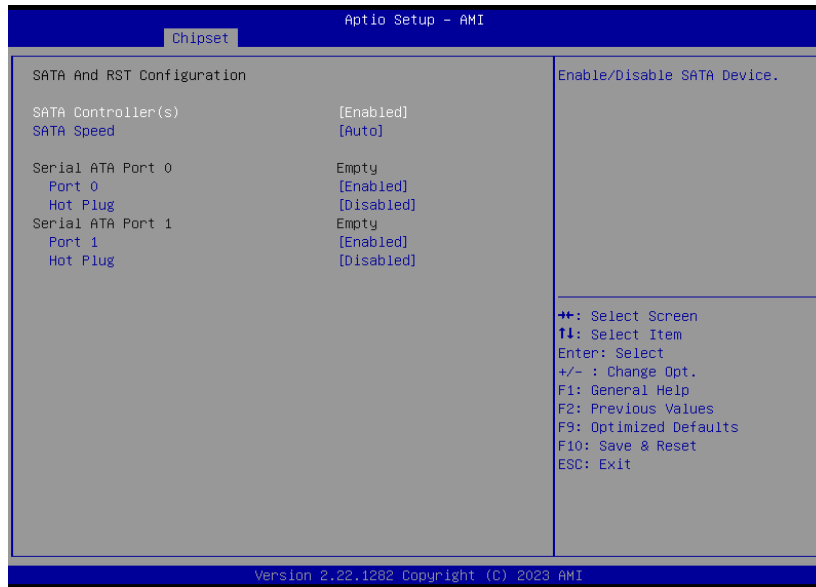

SATA Controller(s)

This field is used to enable or disable the Serial ATA controller.

SATA Speed

This field is used to select SATA speed generation limit: Auto, Gen1, Gen2 or Gen3.

Ports and Hot Plug

Enable or disable the Serial ATA port and its hot plug function.

► Chipset

PCH-IO Configuration ► HD Audio Configuration



HD Audio

Control the detection of the HD Audio device.

- **Disabled** HDA will be unconditionally disabled.
- **Enabled** HDA will be unconditionally enabled.

► Security

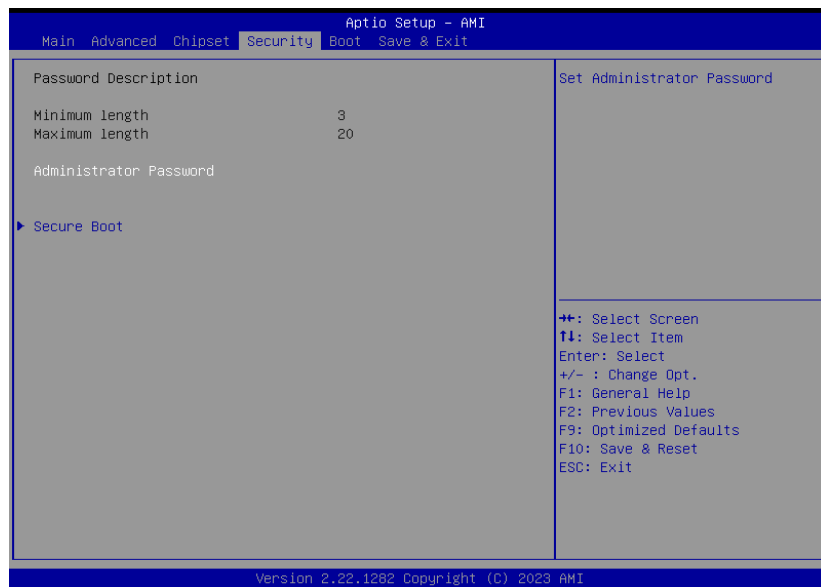

Administrator Password

Set the administrator password. To clear the password, input nothing and press enter when a new password is asked. Administrator Password will be required when entering the BIOS.

► Security

Secure Boot



Secure Boot

The Secure Boot store a database of certificates in the firmware and only allows the OSes with authorized signatures to boot on the system. To activate Secure Boot, please make sure that “Secure Boot” is “[Enabled]”, Platform Key (PK) is enrolled, “System Mode” is “User”, and CSM is disabled. After enabling/disabling Secure Boot, please save the configuration and restart the system. When configured and activated correctly, the Secure Boot status will be “Active”.

Secure Boot Mode

Select the secure boot mode — Standard or Custom. When set to Custom, the following fields will be configurable for the user to manually modify the key database.

Restore Factory Keys

Force system to User Mode. Load OEM-defined factory defaults of keys and databases onto the Secure Boot. Press Enter and a prompt will show up for you to confirm.

Reset To Setup Mode

Clear the database from the NVRAM, including all the keys and signatures installed in the Key Management menu. Press Enter and a prompt will show up for you to confirm.

Key Management

Enables expert users to modify Secure Boot Policy variables without full authentication.

► Boot



Setup Prompt Timeout

Set the number of seconds to wait for the setup activation key. 65535 (0xFFFF) denotes indefinite waiting.

Bootup NumLock State

Select the keyboard NumLock state: On or Off.

Quiet Boot

This section is used to enable or disable quiet boot option.

Boot Option Priorities

Rearrange the system boot order of available boot devices.

Fast Boot

Enables or disables boot with initialization of a minimal set of devices required to launch active boot option. Has no effect for BBS boot options.

Note:
If “Boot option filter” of “CSM Configuration” is set to “UEFI and Legacy” or “UEFI only”, and “Quiet Boot” is set to enabled, “BGRT Logo” will show up for configuration. Refer to the Advanced > CSM Configuration submenu for more information.

► Save & Exit

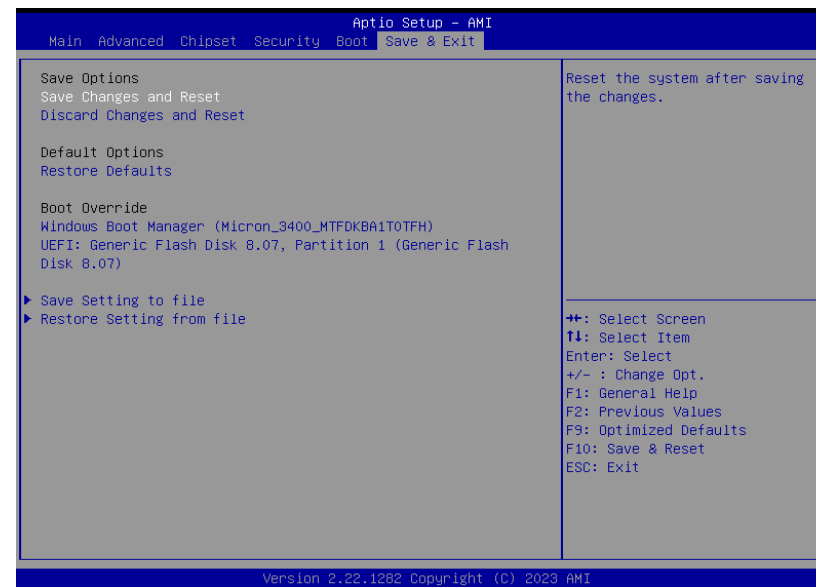

Save Changes and Reset

To save the changes, select this field and then press <Enter>. A dialog box will appear. Select Yes to reset the system after saving all changes made.

Discard Changes and Reset

To discard the changes, select this field and then press <Enter>. A dialog box will appear. Select Yes to reset the system setup without saving any changes.

Restore Defaults

To restore and load the optimized default values, select this field and then press <Enter>. A dialog box will appear. Select Yes to restore the default values of all the setup options.

Boot Override

Move the cursor to an available boot device and press Enter, and then the system will immediately boot from the selected boot device. The Boot Override function will only be effective for the current boot. The “Boot Option Priorities” configured in the Boot menu will not be changed.

• **Save Setting to file** Select this option to save BIOS configuration settings to a USB flash device.

• **Restore Setting from file** This field will appear only when a USB flash device is detected. Select this field to restore setting from the USB flash device.

► Updating the BIOS

To update the BIOS, you will need the new BIOS file and a flash utility. Please contact technical support or your sales representative for the files and specific instructions about how to update BIOS with the flash utility.

► Notice: BIOS SPI ROM

1. The Intel® Management Engine has already been integrated into this system board. Due to the safety concerns, the BIOS (SPI ROM) chip cannot be removed from this system board and used on another system board of the same model.
2. The BIOS (SPI ROM) on this system board must be the original equipment from the factory and cannot be used to replace one which has been utilized on other system boards.
3. If you do not follow the methods above, the Intel® Management Engine will not be updated and will cease to be effective.



Note:

- a. You can take advantage of flash tools to update the default configuration of the BIOS (SPI ROM) to the latest version anytime.
- b. When the BIOS IC needs to be replaced, you have to populate it properly onto the system board after the EEPROM programmer has been burned and follow the technical person's instructions to confirm that the MAC address should be burned or not.
- c. After updating unique MAC Address from manufacturing, NVM will be protected immediately after power cycle. Users cannot update NVM or MAC address.